



FONDERIE D'ART – FONDERIE DE FONTE

FONTE DE BATIMENT N° 33



**LOISELET – LC FOUNDRY, fondeurs de fonte depuis 1850, 6 générations de fondeurs passionnés par la fonte à Nogent-le-Roi fabriquent des pièces pour l'industrie et pour la fonderie d'art. La fonderie Loiselet est votre partenaire idéal pour toutes vos commandes de produits en fonte pour l'industrie, les professionnels, les collectivités et les particuliers.**

VOIR INDEX PRODUITS PAGE 92

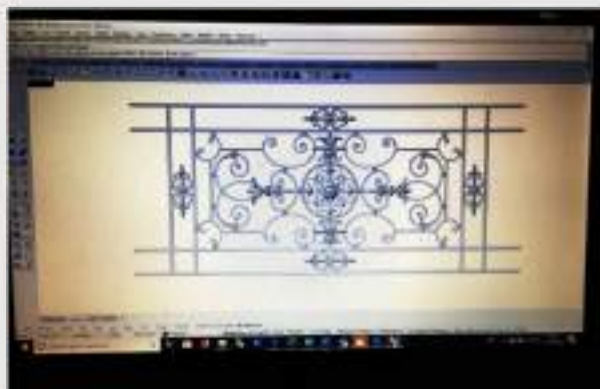

 CREATION DE PLANS 3D

 CREATION D'OUTILLAGES SUIVANT PLANS 3D



 REPRODUCTION DE PIÈCES EN FONTE SANS OUTILLAGE



 FONTE RÉSISTANTE AUX CHOCS ET CONFORME AUX NORMES NFP 01 013 ET NFP 01 012

 + DE 300 MODELES DE GARDE CORPS

# LOISELET

Depuis 1850 à Nogent Le Roi Eure et Loir  
César Loiselet Créateur de l'industrie et de la fonte d'Art  
FONDERIE D'ART FONDERIE DE FONTE ET METALLIER

Eure et Loir Nogent Le Roi

65 rue du faubourg valmorin

## BARRES D'APPUI

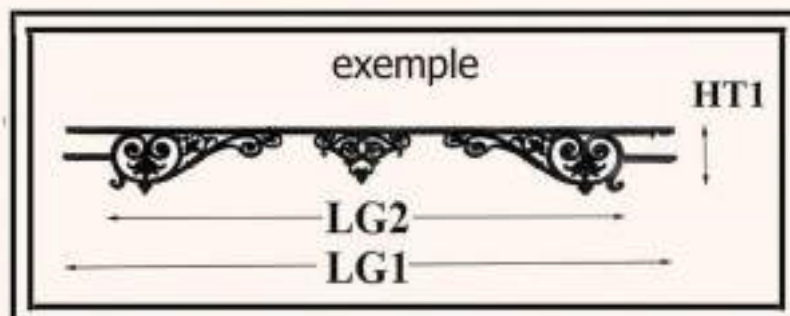

BD

LG1 : 1350mm LG2 : 1085mm LG3 : 970mm

HT1 : 253 mm

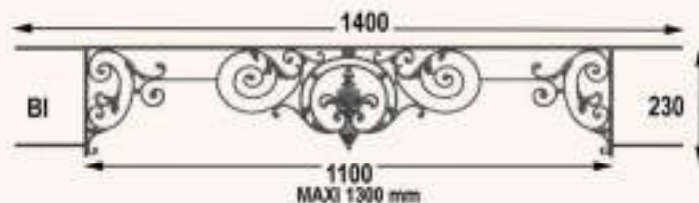
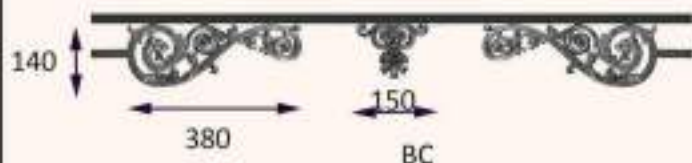

BF

LG1 : 1260mm LG2 : 1040mm

HT1 : 280mm

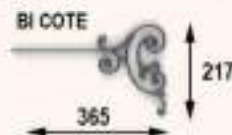

BE

LG1 : 1370mm LG2 : 1190mm

HT1 : 240mm



# LOISELET

Depuis 1850 à Nogent Le Roi Eure et Loir  
 César Loiselet Créateur de l'industrie et de la fonte d'Art  
 FONDERIE D'ART FONDERIE DE FONTE ET METALLIER

Eure et Loir Nogent Le Roi

65 rue du faubourg valmorin

## BARRES D'APPUI



**BJ**  
 LG1 : 1200mm LG2 : 1040mm  
 HT1 : 255mm



**BG**  
 HT1 150 mm LONGUEUR ADAPATBLE



**BL**  
 LG1 : 1440mm LG2 : 1210mm LG3 : 1030mm  
 HT1 : 227mm



**BK**  
 LG1 : 1440mm LG2 : 1210mm LG3 : 1030mm  
 HT1 : 235mm

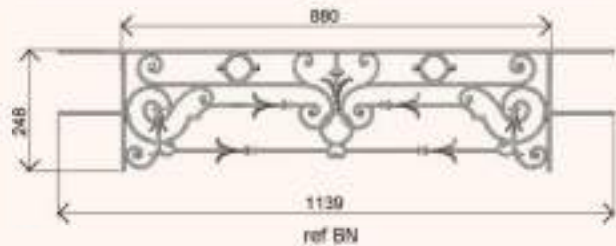

**BM**

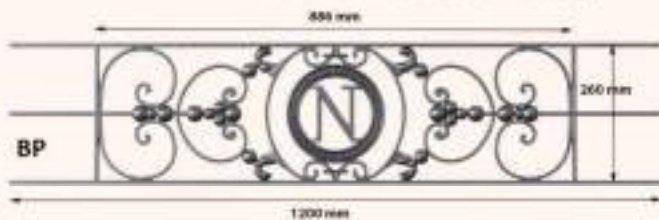
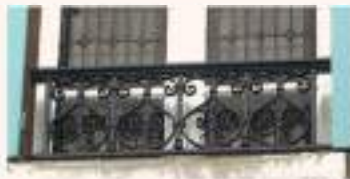

**BP**

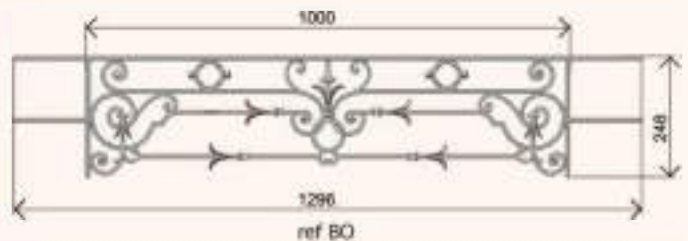

**ref BO**

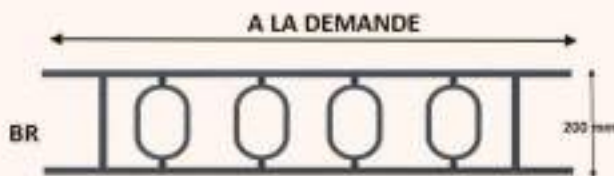

**BR**

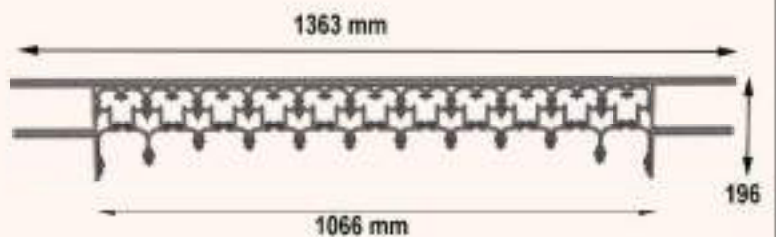

**BS**

# LOISELET

Depuis 1850 à Nogent Le Roi Eure et Loir  
 César Loiselet Créateur de l'industrie et de la fonte d'Art  
**FONDERIE D'ART FONDERIE DE FONTE ET METALLIER**

Eure et Loir Nogent Le Roi

65 rue du faubourg valmorin

## BARRES D'APPUI

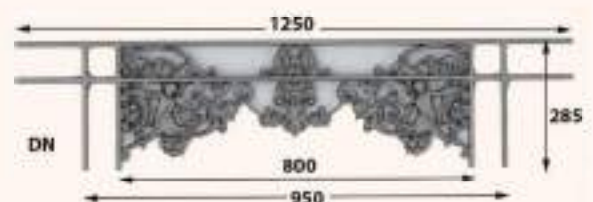
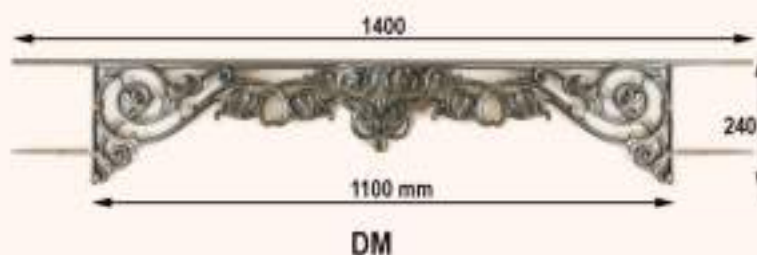
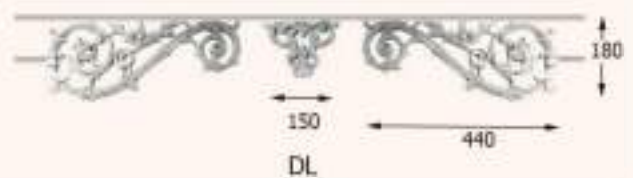
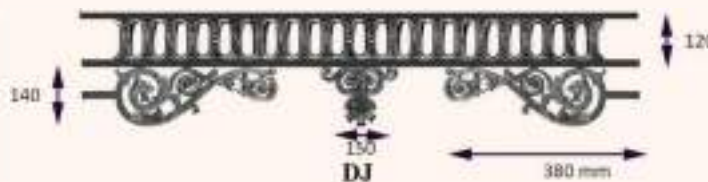
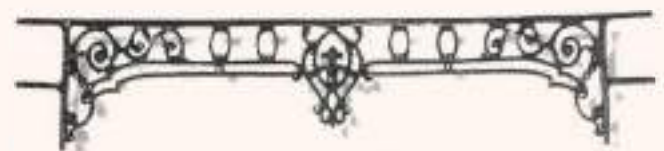
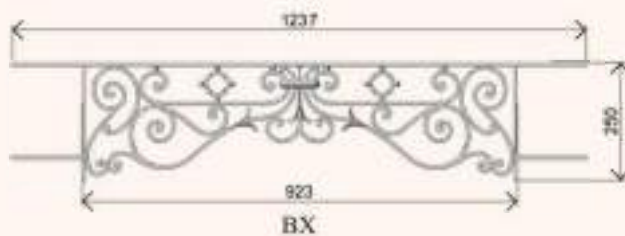
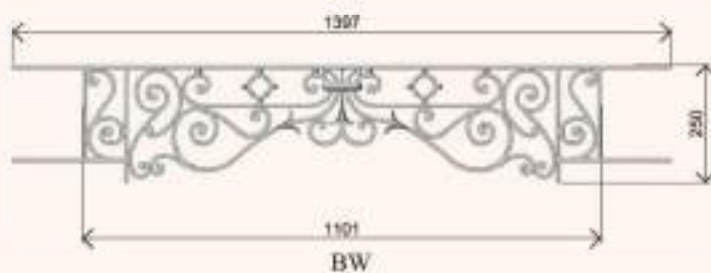
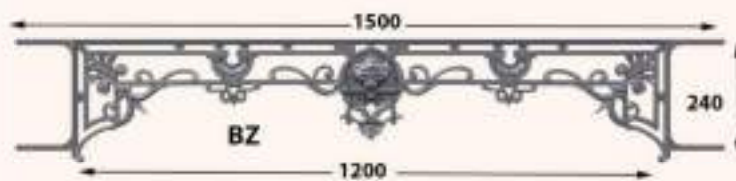

# LOISELET

Depuis 1850 à Nogent Le Roi Eure et Loir  
César Loiselet Créateur de l'industrie et de la fonte d'Art  
FONDERIE D'ART FONDERIE DE FONTE ET METALLIER

Eure et Loir Nogent Le Roi

65 rue du faubourg valmorin

## BARRES D'APPUI



HT1 200 mm LONGUEUR ADAPTABLE

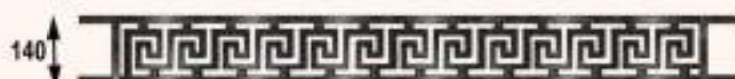

DP  L 180 mm \* H120 mm



DX

LG1 : 1110mm LG2 : 890 mm  
HT1 : 230mm

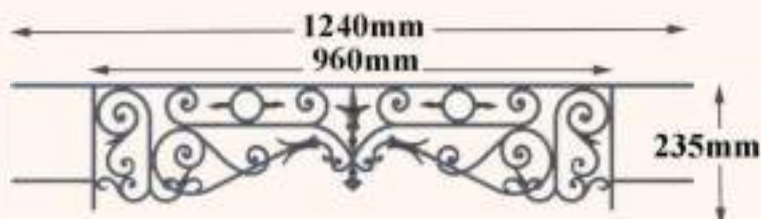

DT



DW

LG1 : 1480mm LG2 : 1235mm  
HT1 : 360mm HT2 : 260mm

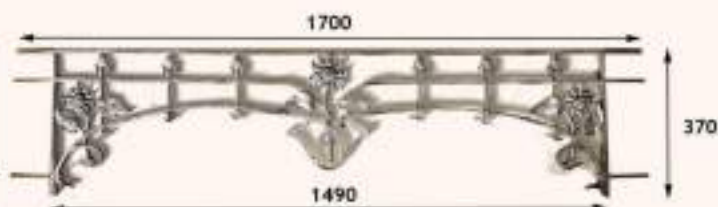

DZA



FB

HT1 : 265mm  
LG1 : 1500mm LG2 : 1300mm LG3 : 1145mm



FD

HT1 : 222mm  
LG1 : 1290mm LG2 : 960mm



FA

HT1 : 370mm  
LG1 : 1310mm LG2 : 1091mm

# LOISELET

Depuis 1850 à Nogent Le Roi Eure et Loir  
César Loiselet Créateur de l'industrie et de la fonte d'Art  
FONDERIE D'ART FONDERIE DE FONTE ET METALLIER

Eure et Loir Nogent Le Roi

65 rue du faubourg valmorin

## BARRES D'APPUI



**FC**  
HT1 : 268mm  
LG1 : 1350mm LG2 : 1105mm



**FE**  
LG1 : 1500mm LG2 : 950mm  
HT1 : 260mm



**FF**  
LG1 : 1465mm LG2 : 1335mm  
HT1 : 290mm



**FH**  
LG1 : 1390mm LG2 : 1170mm  
HT1 : 220mm



**FI**  
LG1 : 1260mm LG2 : 885mm  
HT1 : 230mm



**FM**  
LG1 : 1290mm LG2 : 930mm  
HT1 : 285mm

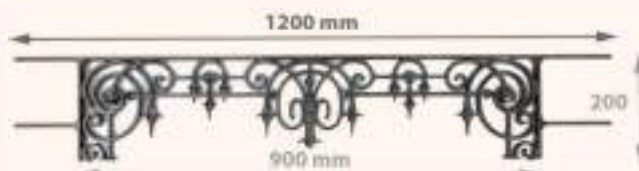

**FJ**

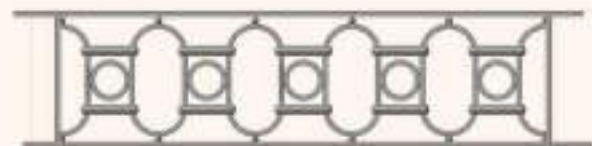

**FK**



**FO**  
LG1 : 1100mm LG2 : 1000mm  
HT1 : 260mm

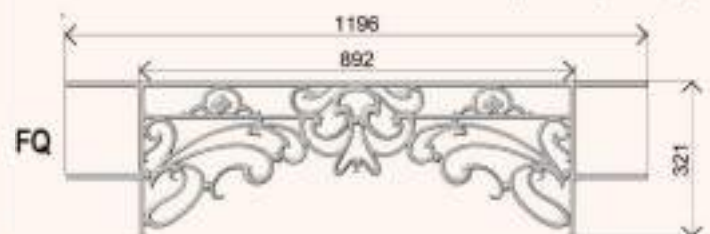

**FQ**

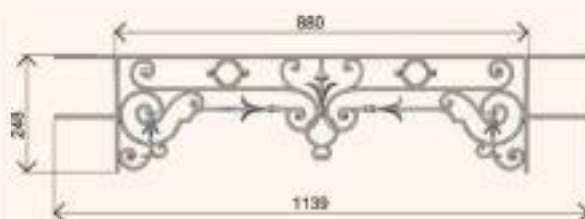

**FP**  
LG1 : 1139mm LG2 : 880 mm  
HT1 : 248 mm

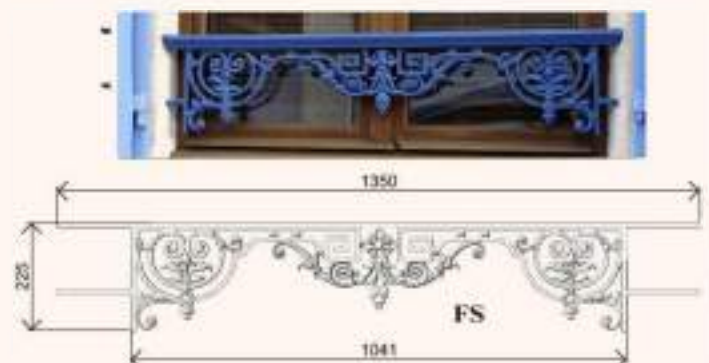

**FS**

# LOISELET

Depuis 1850 à Nogent Le Roi Eure et Loir  
César Loiselet Créateur de l'industrie et de la fonte d'Art  
FONDERIE D'ART FONDERIE DE FONTE ET METALLIER

Eure et Loir Nogent Le Roi

65 rue du faubourg valmorin

## BARRES D'APPUI



**FX**  
LG1 : 1060mm LG2 : 925mm  
HT1 : 180mm



**FT**  
LG1 : 1075mm LG2 : 790mm  
HT1 : 205mm



**FY**  
150 380



**FR**  
LG1 : 1296 mm LG2 : 990mm  
HT1 : 250mm



**FW**  
LG1 : 1275mm LG2 : 1115mm  
HT1 : 250mm

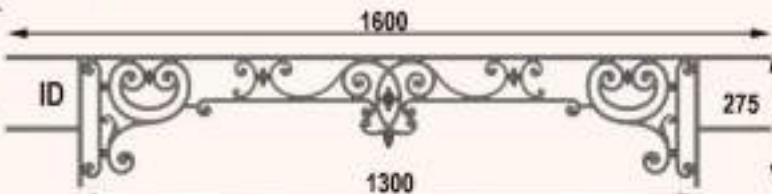
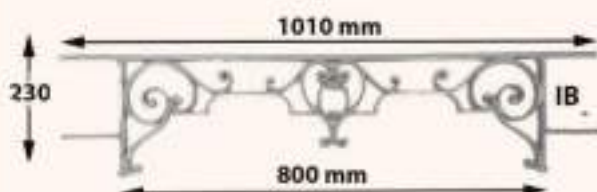
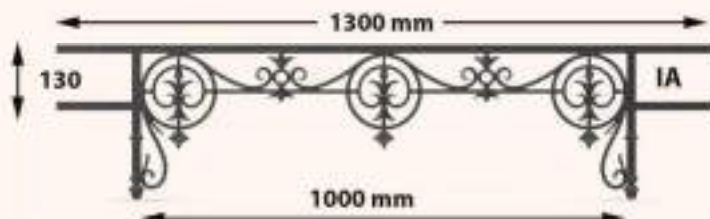
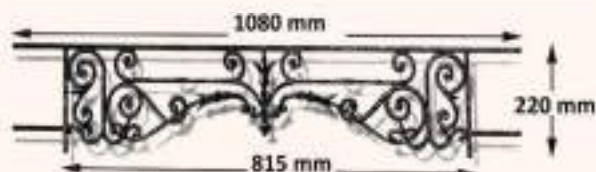
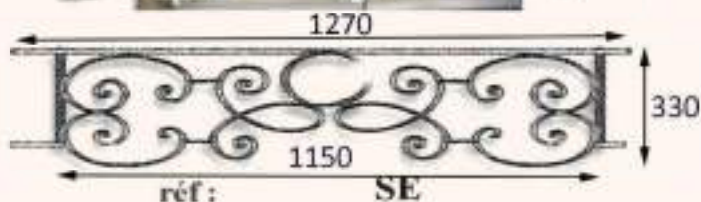
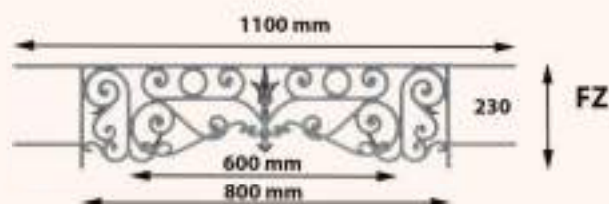
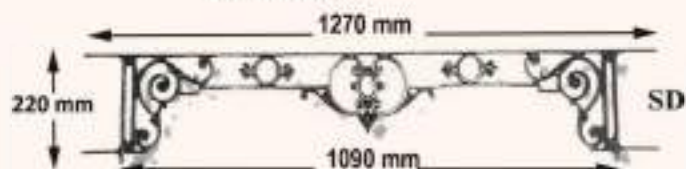
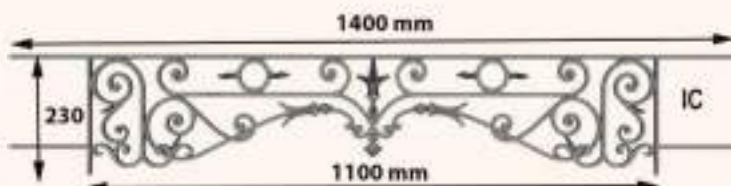



# LOISELET

Depuis 1850 à Nogent Le Roi Eure et Loir  
César Loiselet Créateur de l'industrie et de la fonte d'Art  
FONDERIE D'ART FONDERIE DE FONTE ET METALLIER

Eure et Loir Nogent Le Roi

65 rue du faubourg valmorin

## BALCONS DE CROISEES

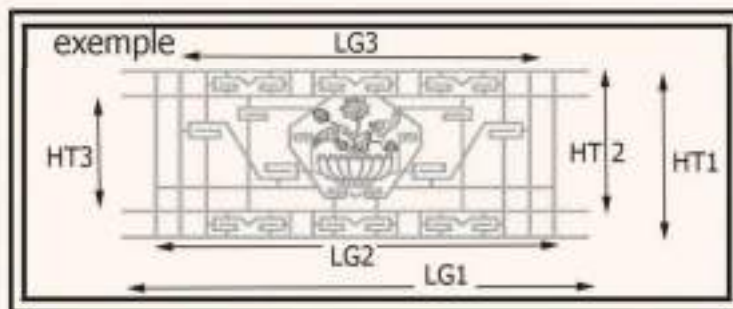

JCB

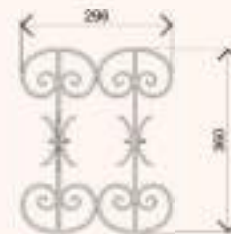

JCD

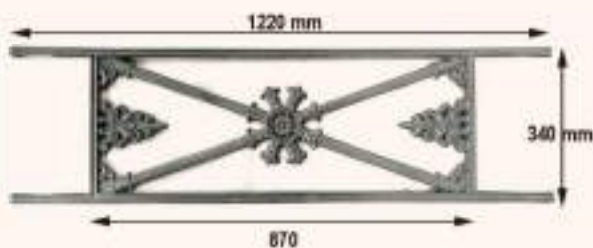

DS

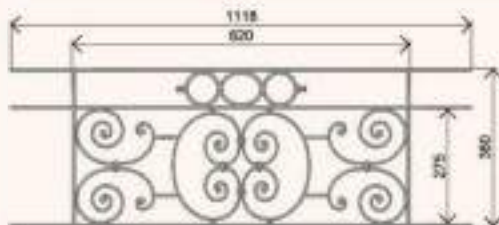

JA



JB

HT1 : 420mm HT2 : 340 mm  
LG1 : 1640 mm LG2 : 1240 mm LG3 : 1080mm

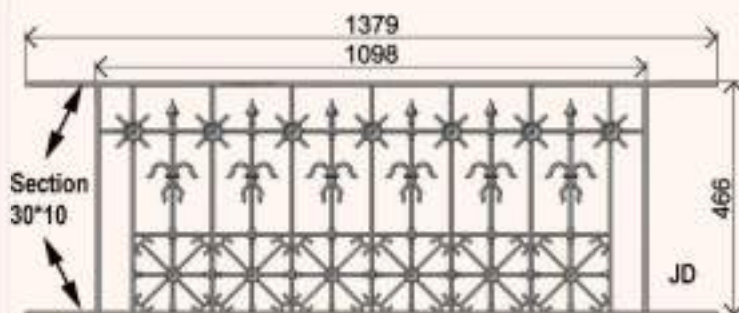

JD



JE

HT1 : 450 mm  
LG1 : 1500mm LG2 : 1300mm

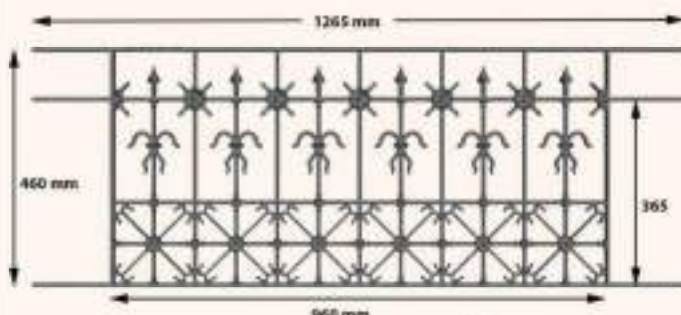

JH

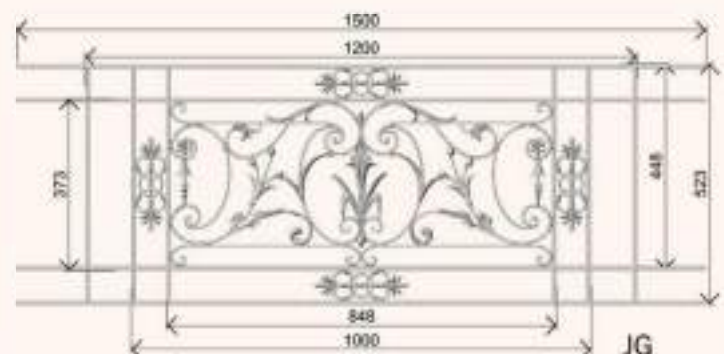

JG

# LOISELET

Depuis 1850 à Nogent Le Roi Eure et Loir  
César Loiselet Créateur de l'industrie et de la fonte d'Art  
FONDERIE D'ART FONDERIE DE FONTE ET METALLIER

Eure et Loir Nogent Le Roi

65 rue du faubourg valmorin

ref 1552

JMM

86\*175

BALCONS DE CROISEES

JN



HT1 : 480 mm  
LG1 : 1445 mm - LG2 : 1212 mm

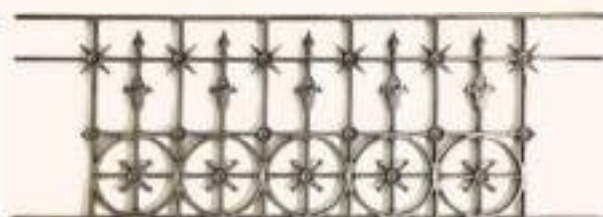

HT1 : 450 mm - HT2 : 357 mm  
LG1 : 1264 mm LG2 930 mm



JM

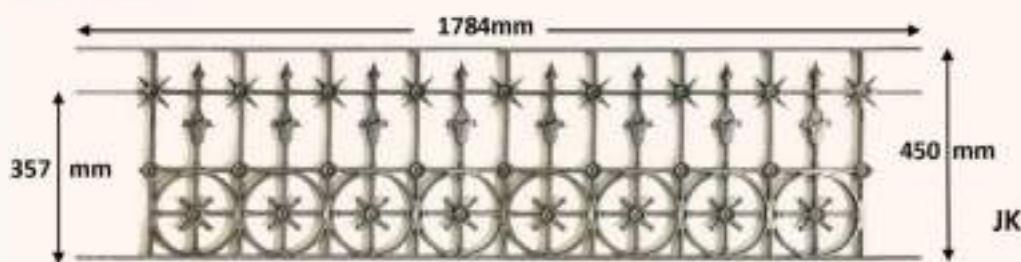

JK

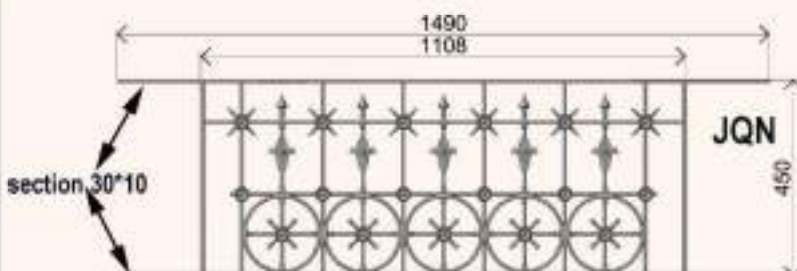

JQN



JL  
320\*368



JF



JP

HT1: 590 mm - HT2 : 507,5 - HT3 : 425 mm  
LG1 : 1355 - LG2 : 1110 mm - LG3 : 950 mm



JO

HT1 : 580 mm - HT2 : 491 mm - HT3 : 404 mm  
LG1 : 1330 mm - LG2 : 1145 mm - LG3 : 1005 mm

# LOISELET

Depuis 1850 à Nogent Le Roi Eure et Loir  
César Loiselet Créateur de l'industrie et de la fonte d'Art  
FONDERIE D'ART FONDERIE DE FONTE ET METALLIER

Eure et Loir Nogent Le Roi

65 rue du faubourg valmorin

## BALCONS DE CROISEES

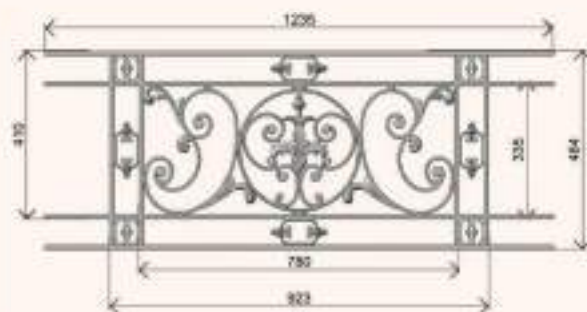
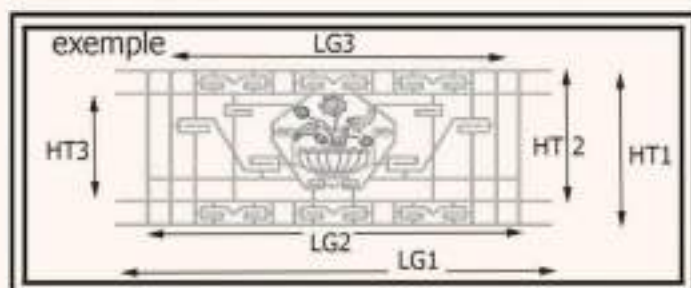

JS



JT

HT1 : 385 mm HT2 : 303 mm  
LG1 : 1444 mm LG2 1168 mm LG3 1010 mm



JV

HT1 : 580 mm - HT2 : 480 mm  
LG1 : 1215 mm - LG2 : 945 mm

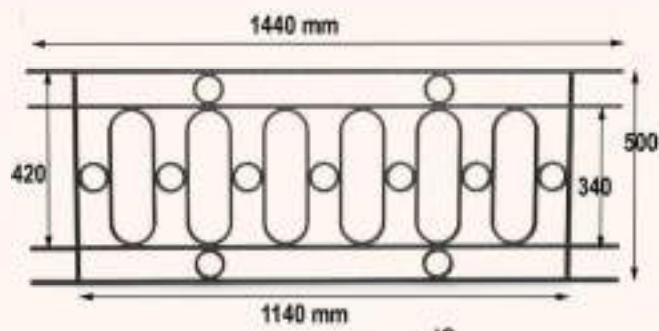
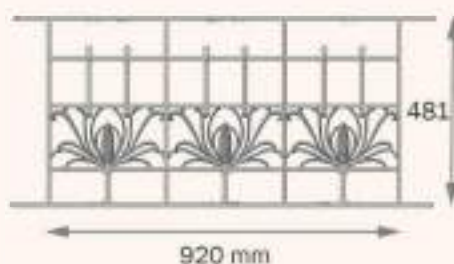
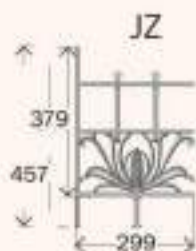
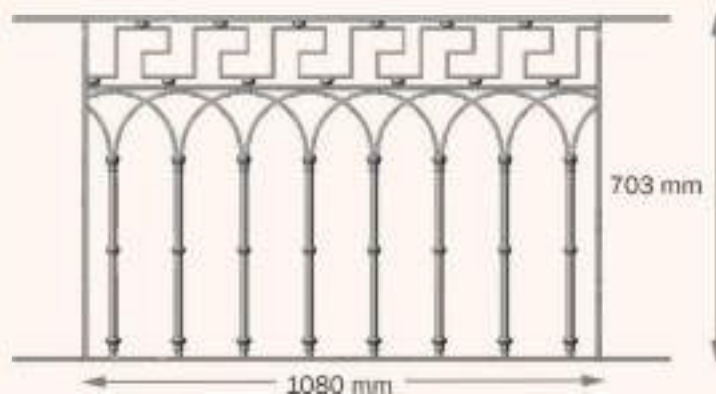
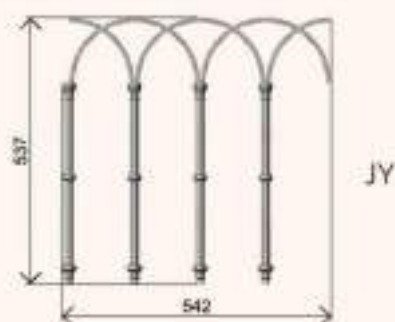
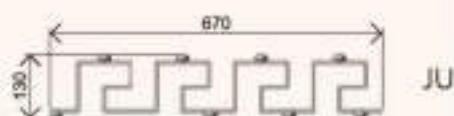

JQ

# LOISELET

Depuis 1850 à Nogent Le Roi Eure et Loir  
César Loiselet Créateur de l'industrie et de la fonte d'Art  
FONDERIE D'ART FONDERIE DE FONTE ET METALLIER

Eure et Loir Nogent Le Roi

65 rue du faubourg valmorin

## BALCONS DE CROISEES

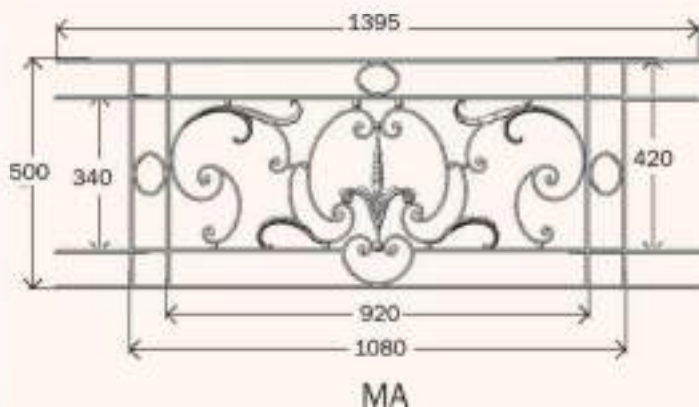
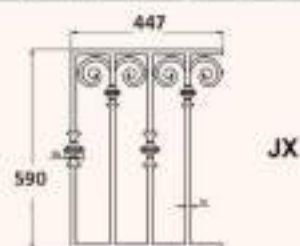
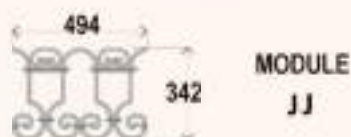

**MD**  
HT1 : 580mm HT2 : 480mm HT3 :  
LG1 : 1600mm LG2 : 1220mm LG3 : 1005mm



**MC**  
HT1 : 530mm HT2 : 446mm HT3 : 358mm  
LG1 : 1357mm LG2 : 980mm LG3 :



**MB**  
HT1 : 305mm HT2 :  
LG1 : 1440mm LG2 : 1140mm LG3 : 980mm

# LOISELET

Depuis 1850 à Nogent Le Roi Eure et Loir  
César Loiselet Créateur de l'industrie et de la fonte d'Art  
FONDERIE D'ART FONDERIE DE FONTE ET METALLIER

Eure et Loir Nogent Le Roi

65 rue du faubourg valmorin

## BALCONS DE CROISEES

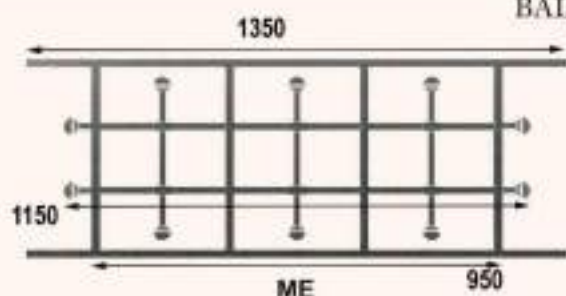

**ME**  
HT1 : 460mm  
LG1 1250mm LG2 950mm

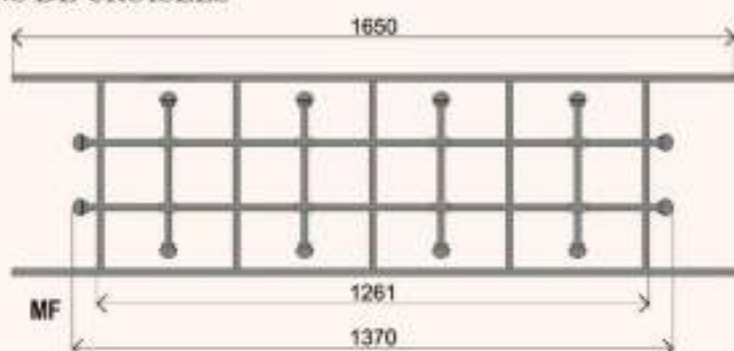

**MF**



**MH**  
HT1 : 467mm HT2 : 387mm HT3 : 307mm  
LG1 : 1662mm LG2 : 1297mm LG3 : 1136mm

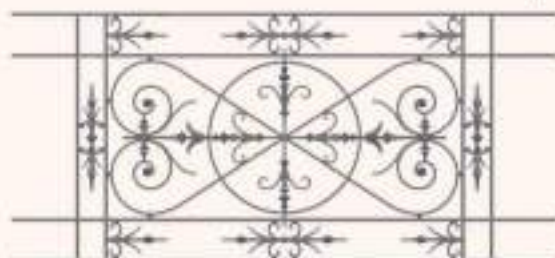

**MG**  
HT1 : 590 mm HT2 : 505mm HT3 : 412mm  
LG1 : 1315 mm LG2 : 1015mm LG3 : 878mm

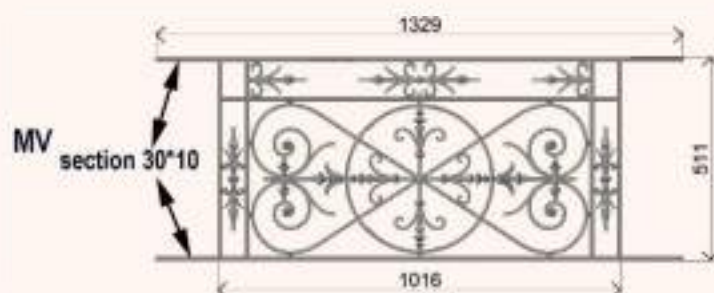

**MV**  
section 30\*10



**MI**  
HT1 : 420mm HT2 : mm HT3 :  
LG1 : 1350mm LG2 : 1050mm LG3 :

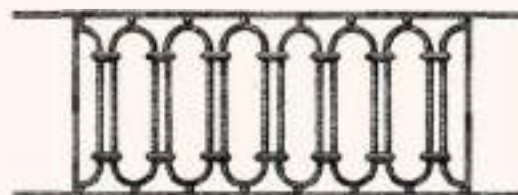

**MJ**  
HT1 : 440 mm  
LG1 : 1350 mm LG2 1020 mm



**MK**  
380\*360 de haut



**MN**  
290\*260 mm de haut

# LOISELET

Depuis 1850 à Nogent Le Roi Eure et Loir  
César Loiselet Créateur de l'industrie et de la fonte d'Art  
FONDERIE D'ART FONDERIE DE FONTE ET METALLIER

Eure et Loir Nogent Le Roi

65 rue du faubourg valmorin

## BALCONS DE CROISEES

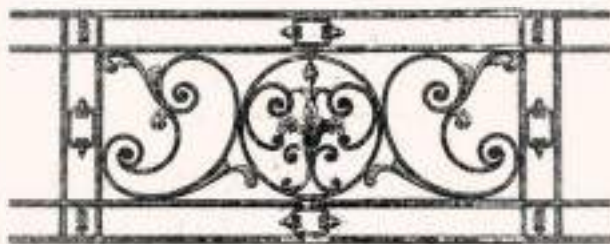

**ML**  
HT1 : 485mm HT2 : 410mm HT3 : 335mm  
LG1 : 1340mm LG2 : 1026mm LG3 : 880mm

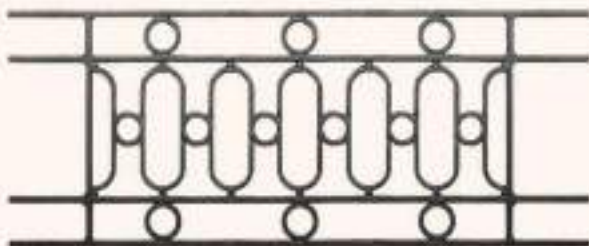
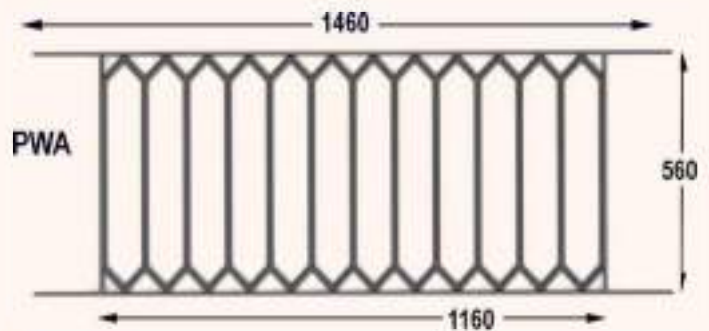

**MP**  
HT1 : 620mm HT2 : 500mm HT3 : 385mm  
LG1 : 1600mm LG2 : 1175mm LG3 :

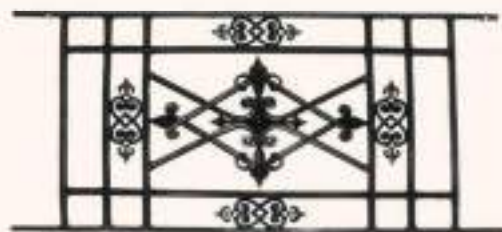

**MM**  
HT1 : 520mm HT2 : 440mm HT3 : 353mm  
LG1 : 1080mm LG2 : 863mm LG3 : 685mm



**MR**  
HT1 : 580mm LG1 : 1570mm LG2 : 1385mm

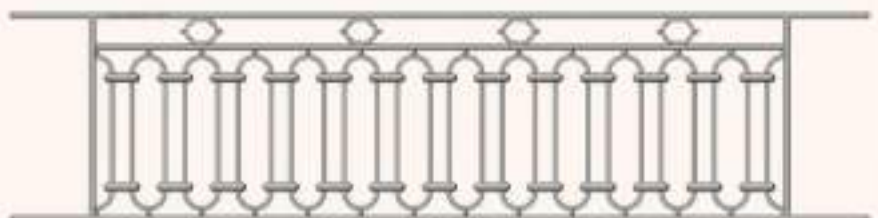
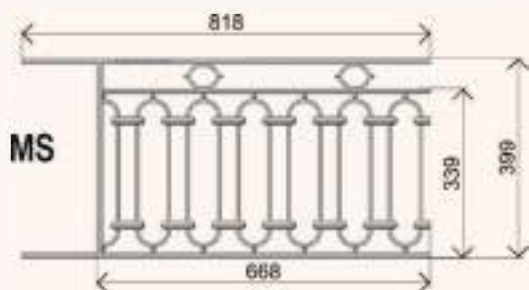
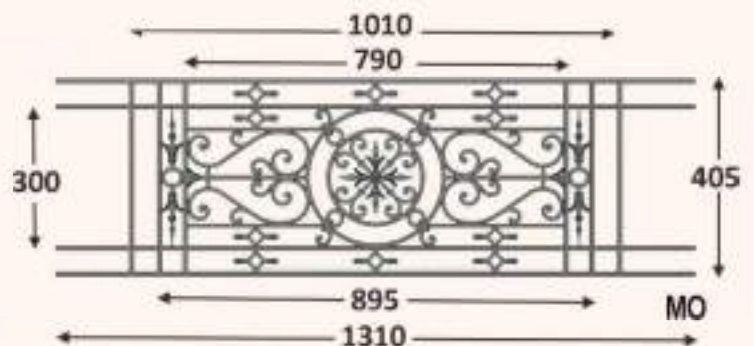

# LOISELET

Depuis 1850 à Nogent Le Roi Eure et Loir  
César Loiselet Créateur de l'industrie et de la fonte d'Art  
FONDERIE D'ART FONDERIE DE FONTE ET METALLIER

Eure et Loir Nogent Le Roi

65 rue du faubourg valmorin

## BALCONS DE CROISEES

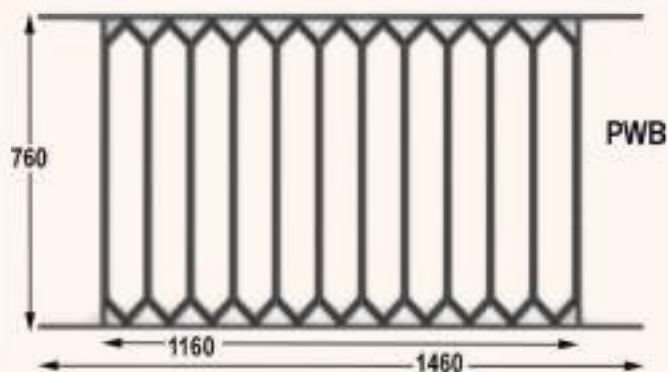
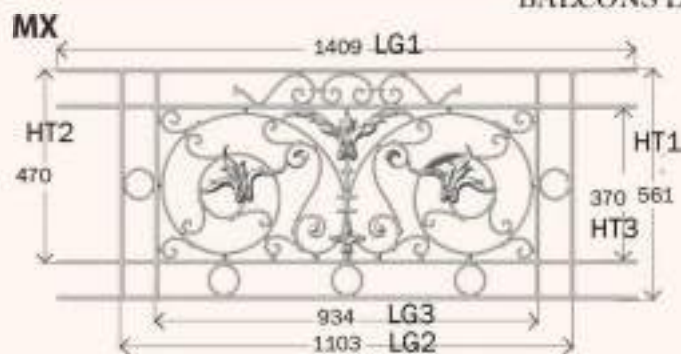

**MX**

LG1 : 1340mm LG2 : 1110mm LG3 : 930 mm  
HT1 : 530mm HT2 : 440mm HT3 : 350 mm

**PWB**

LG1 : 1300mm LG2 : 1100 mm LG3 : 900mm  
HT1 : 490 mm HT2 : 405 mm



**NS**

HT1 : 580mm  
LG1 : 2040mm LG2 : 1640mm LG3 : 1480 mm

**NW**

LG1 : 1379 mm - LG2 : 1081 mm - LG3 : 893 mm  
HT1 : 519 mm - HT2 : 428 mm - HT3 : 336 mm



**OA**

HT1 : 542mm HT2 : 459mm HT3 : 375mm  
LG1 : 1450mm LG2 : 1150mm LG3 : 980mm

**OD**

HT1 : 350mm HT2 : mm HT3 :  
LG1 : 910mm LG2 : 695mm LG3 :

# LOISELET

Depuis 1850 à Nogent Le Roi Eure et Loir  
César Loiselet Créateur de l'industrie et de la fonte d'Art  
FONDERIE D'ART FONDERIE DE FONTE ET METALLIER

Eure et Loir Nogent Le Roi

65 rue du faubourg valmorin

## BALCONS DE CROISEES



OC

HT1 : 524 mm HT2 : 440mm HT3 : 355mm  
LG1 : 1409 mm LG2 : 1109 mm LG3 : 1409 mm



OG

HT1 : 535mm HT2 : 450mm HT3 :  
LG1 : 1590mm LG2 : 1390mm LG3 :



OF

HT1 : 375mm HT2 : 322mm HT3 :  
LG1 : 1060mm LG2 : 815mm LG3 :



OH

HT1 : 566mm HT2 : 472mm HT3 : 382mm  
LG1 : 1530mm LG2 : 1480mm LG3 :



OI

HT1 : 530mm HT2 : 440mm HT3 :  
LG1 : 1210mm LG2 : 1000mm LG3 :



OJ

HT1 : 320mm HT2 : HT3 :  
LG1 : 1140mm LG2 : 925mm LG3 : 775mm



OK

HT1 : 495mm HT2 : 415mm HT3 : 335mm  
LG1 : 1330mm LG2 : 1110mm LG3 : 945mm



# LOISELET

Depuis 1850 à Nogent Le Roi Eure et Loir  
César Loiselet Créateur de l'industrie et de la fonte d'Art  
FONDERIE D'ART FONDERIE DE FONTE ET METALLIER

Eure et Loir Nogent Le Roi

65 rue du faubourg valmorin

## BALCONS DE CROISEES



**OM**  
HT1 : 450mm HT2 : 353mm HT3 :  
LG1 : 1385mm LG2 : 1125mm LG3 : 940mm



**OL**  
HT1 530mm HT2 460mm  
LG1 1600mm LG2 1370mm LG3 1200mm LG4 1060mm



**OW**  
HT1 : 410mm HT2 : 330mm  
LG1 : 1435mm LG2 : 1085mm LG3 : 945mm



**OO**  
HT1 400 mm  
LG1 1410 mm LG2 1170 mm



**OZ**  
HT1 400 mm  
LG1 1370 mm LG2 920 mm



**ON**  
HT1 : 460mm  
LG1 : 1660mm  
LG2 : 1460mm

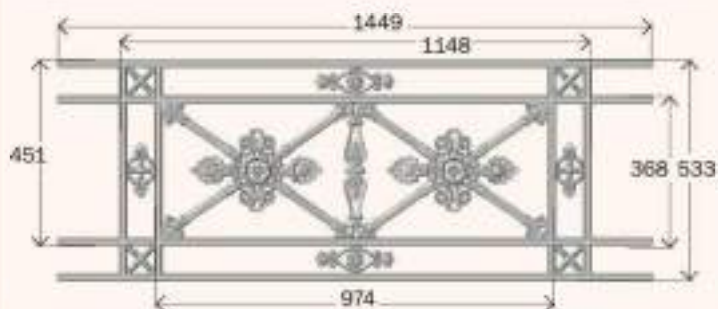

**PA**



**OT**

# LOISELET

Depuis 1850 à Nogent Le Roi Eure et Loir  
César Loiselet Créateur de l'industrie et de la fonte d'Art  
FONDERIE D'ART FONDERIE DE FONTE ET METALLIER

Eure et Loir Nogent Le Roi

65 rue du faubourg valmorin

## BALCONS DE CROISEES



**PB**  
HT1 : 375mm HT2 : HT3 :  
LG1 : 1205mm LG2 : 1020mm LG3 : 875mm

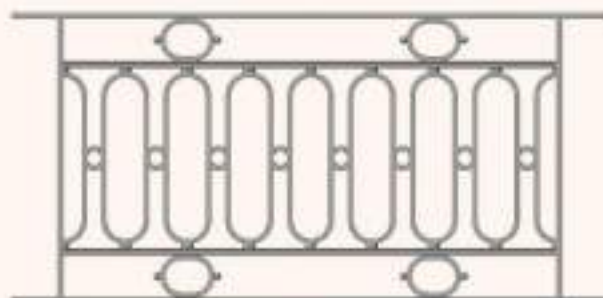

**PC**  
HT1 : 569 HT2 : 482 HT3 : 394  
LG1 : 505 mm

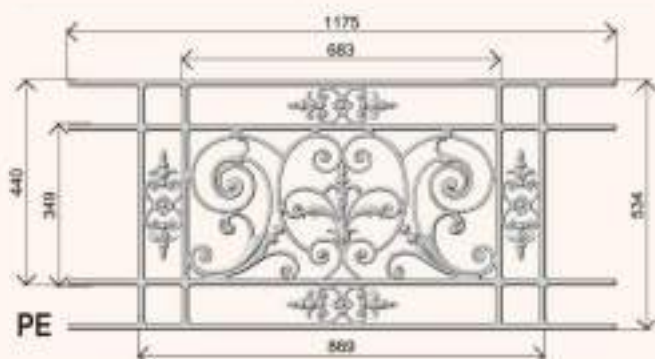
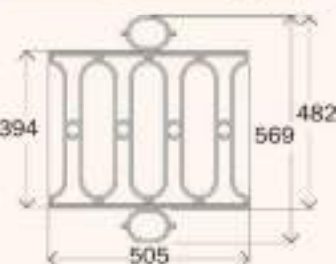

**PE**



**PL**  
HT1 : 450mm HT2 : 372mm HT3 :  
LG1 : 1315mm LG2 : 1075mm LG3 : 925mm



**PN**  
HT1 : 485mm HT2 : 410mm HT3 :  
LG1 : 1200mm LG2 : 940mm LG3 :



**PO**  
HT1 : 315mm HT2 : HT3 :  
LG1 : 1330mm LG2 : 1050mm LG3 : 800mm



**PR**  
HT1 : 525mm HT2 : 410mm HT3 :  
LG1 : 1185mm LG2 : 1070mm LG3 :



**PS**  
HT1 : 420 mm  
LG1 : 1300 mm - LG2 : 900 mm

# LOISELET

Depuis 1850 à Nogent Le Roi Eure et Loir  
César Loiselet Créateur de l'industrie et de la fonte d'Art  
FONDERIE D'ART FONDERIE DE FONTE ET METALLIER

Eure et Loir Nogent Le Roi

65 rue du faubourg valmorin

## BALCONS DE CROISEES

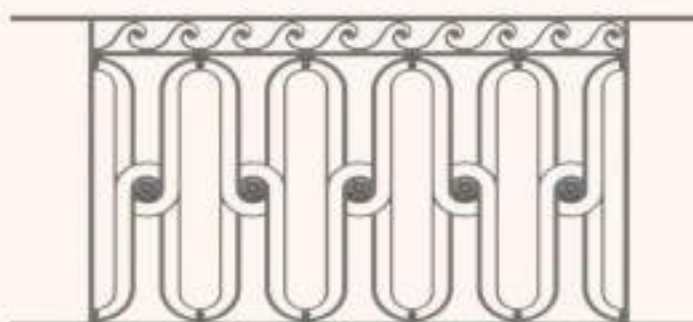
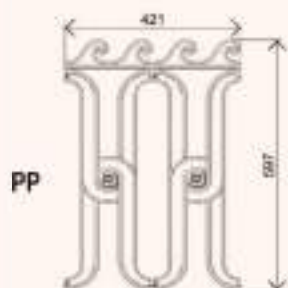
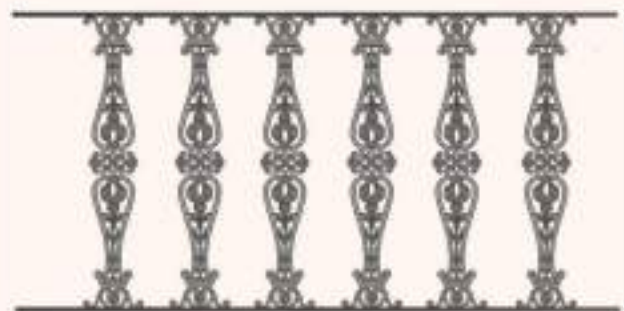
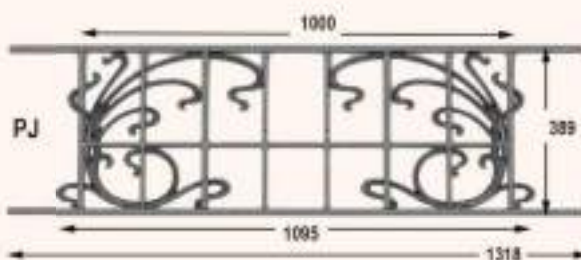
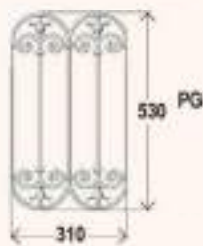
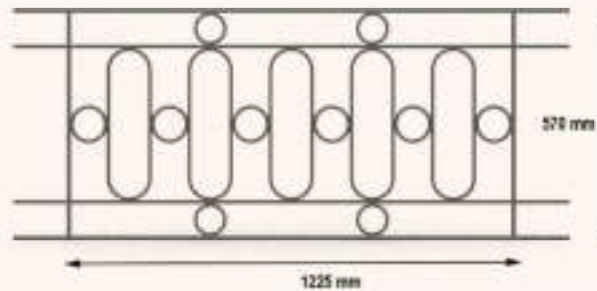
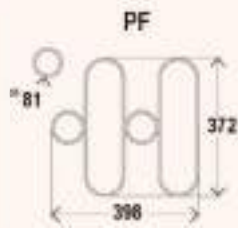

# LOISELET

Depuis 1850 à Nogent Le Roi Eure et Loir  
César Loiselet Créateur de l'industrie et de la fonte d'Art  
FONDERIE D'ART FONDERIE DE FONTE ET METALLIER

Eure et Loir Nogent Le Roi

65 rue du faubourg valmorin

## BALCONS DE CROISEES

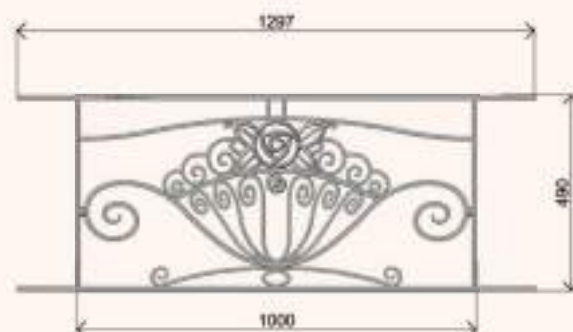
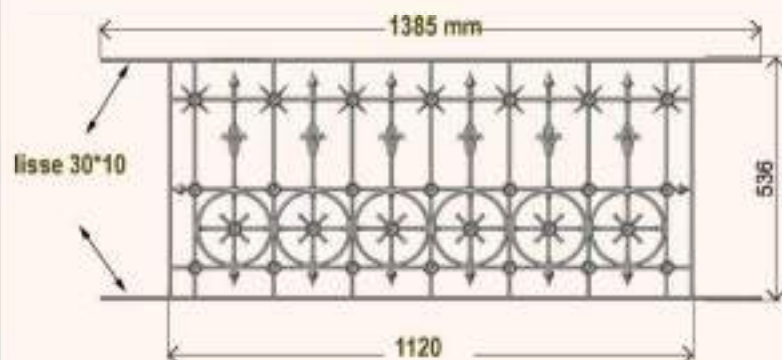
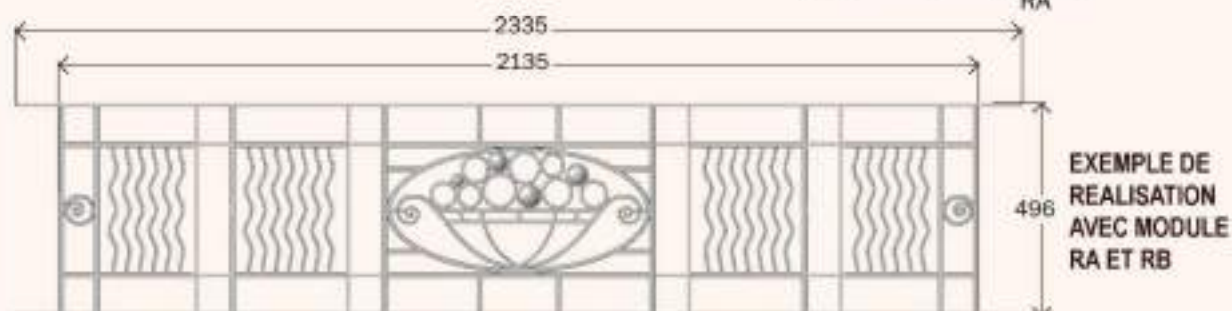
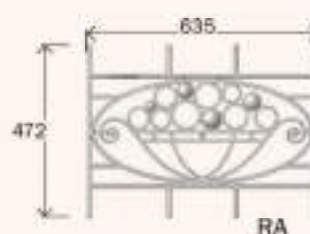
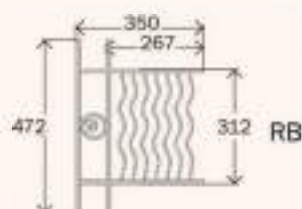
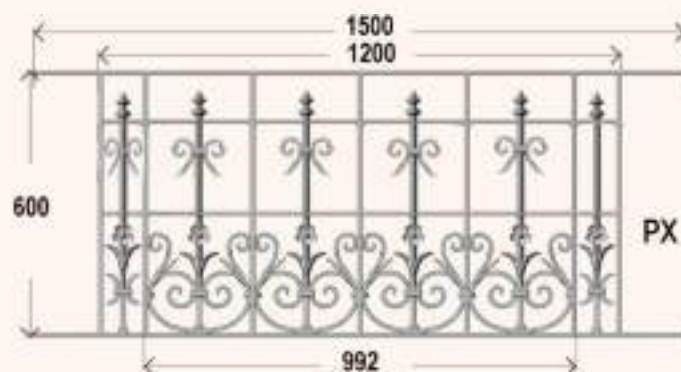
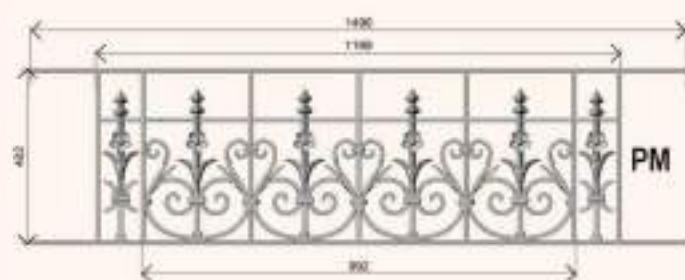
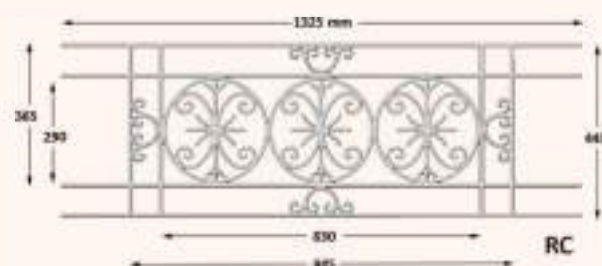
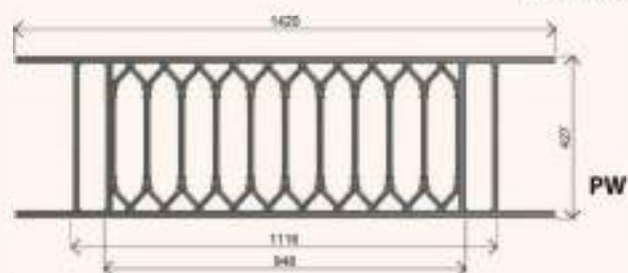

RF

RD

# LOISELET

Depuis 1850 à Nogent Le Roi Eure et Loir  
César Loiselet Créateur de l'industrie et de la fonte d'Art  
FONDERIE D'ART FONDERIE DE FONTE ET METALLIER

Eure et Loir Nogent Le Roi

65 rue du faubourg valmorin

## BALCONS DE CROISEES

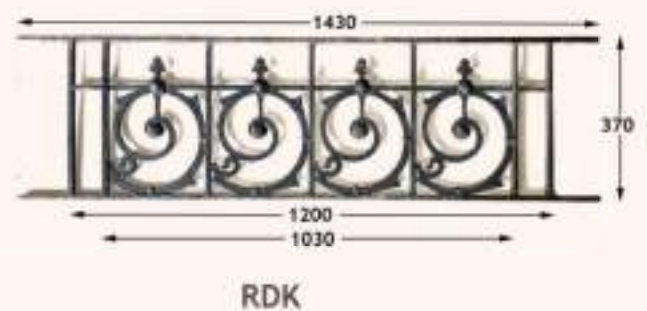
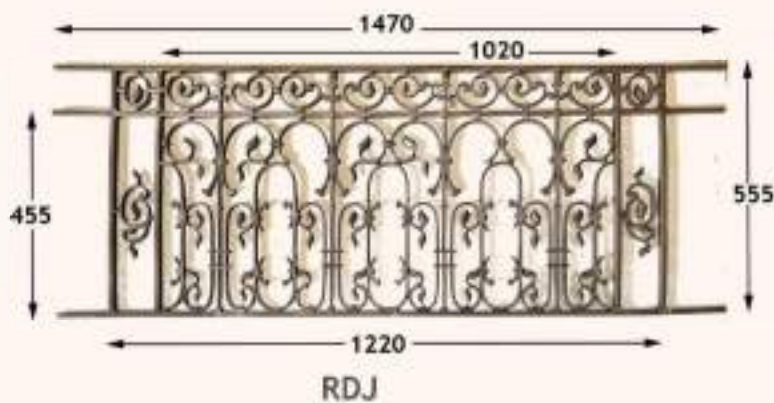
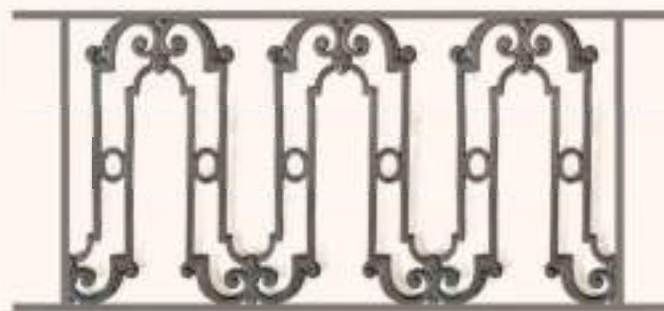
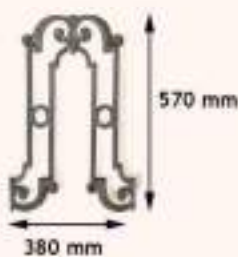
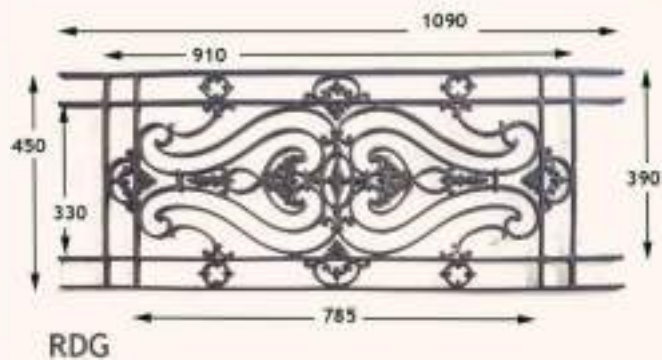
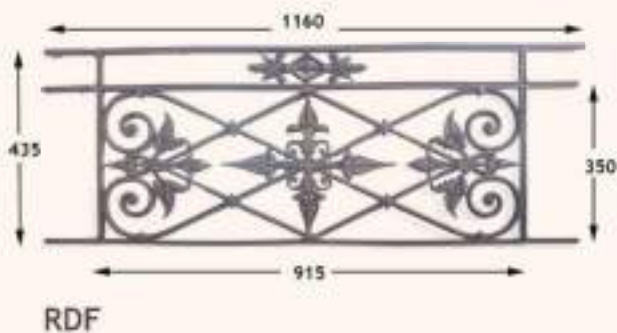
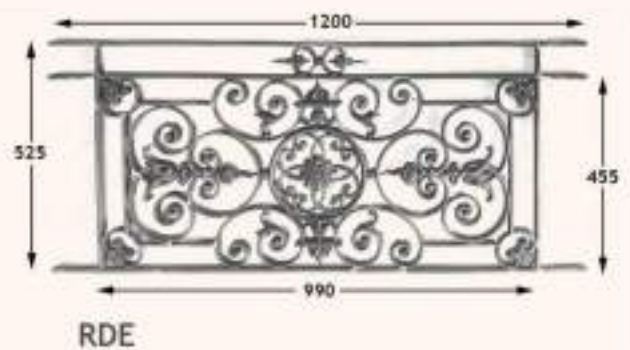
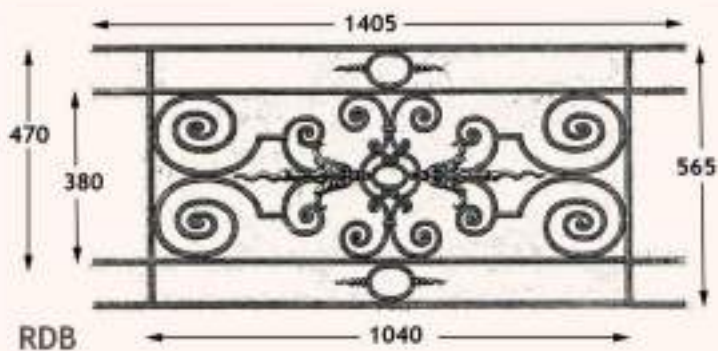

# LOISELET

Depuis 1850 à Nogent Le Roi Eure et Loir  
César Loiselet Créateur de l'industrie et de la fonte d'Art  
FONDERIE D'ART FONDERIE DE FONTE ET METALLIER

Eure et Loir Nogent Le Roi

65 rue du faubourg valmorin

## BALCONS DE CROISEES

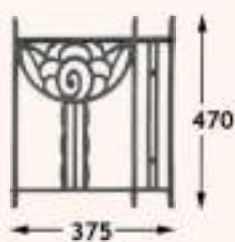

RDM



RDP

1480

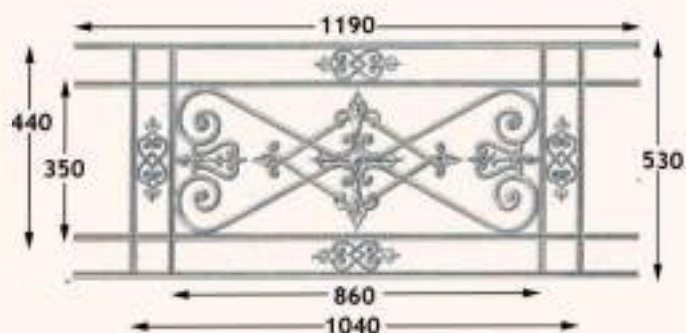

RDQ

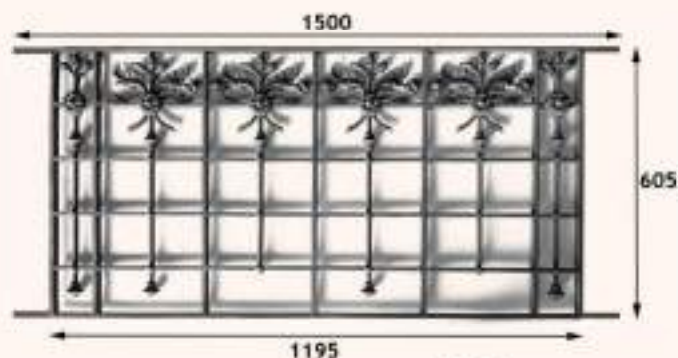

RDR

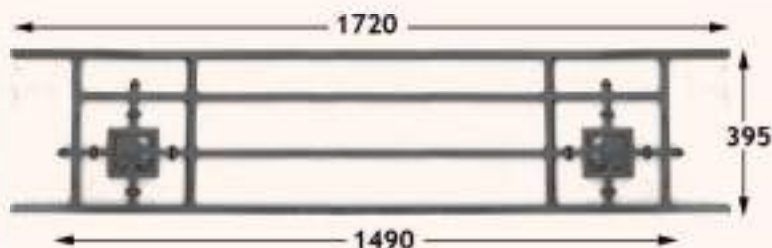

RDT

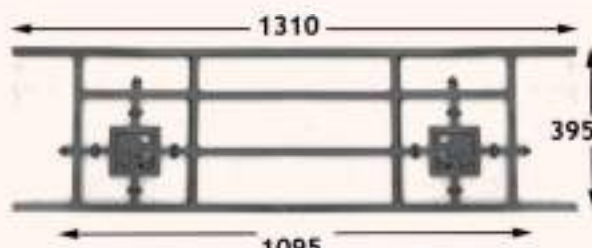

RDV

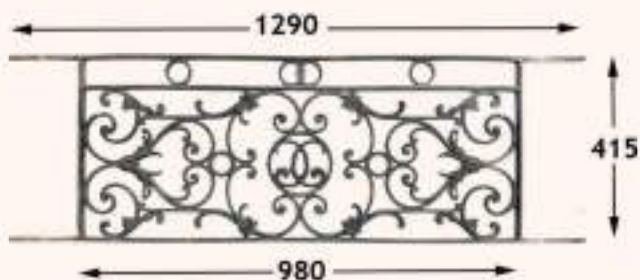

RDX

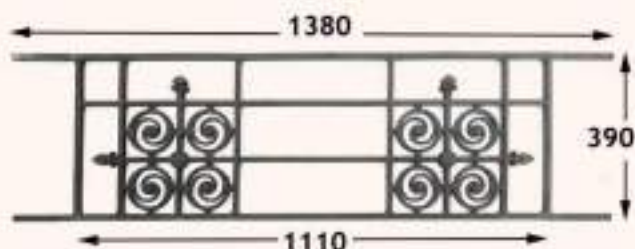

RDW

# LOISELET

Depuis 1850 à Nogent Le Roi Eure et Loir  
 César Loiselet Créateur de l'industrie et de la fonte d'Art  
**FONDERIE D'ART FONDERIE DE FONTE ET METALLIER**

Eure et Loir Nogent Le Roi

65 rue du faubourg valmorin

## BALCONS DE CROISEES

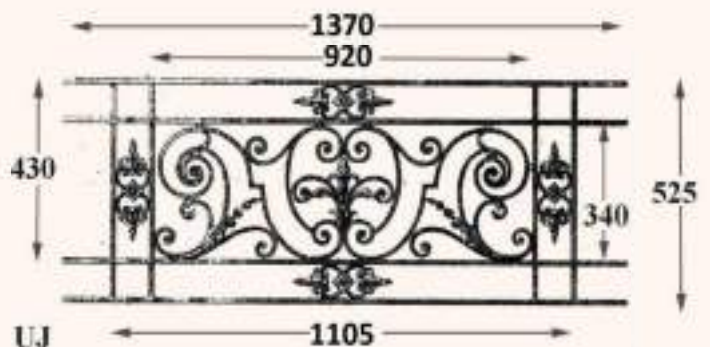
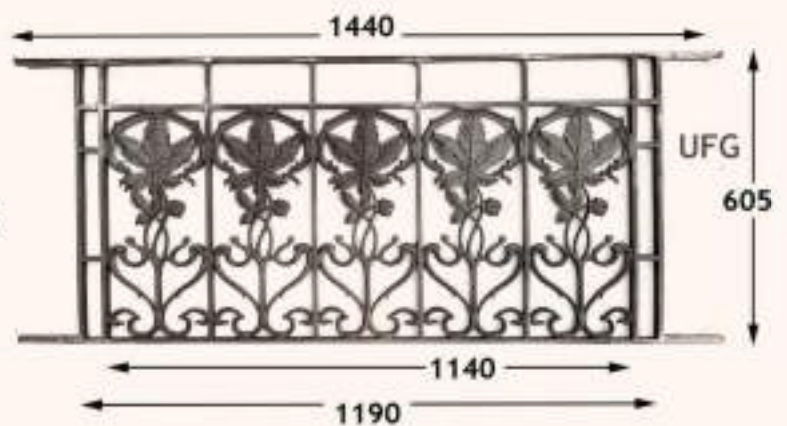
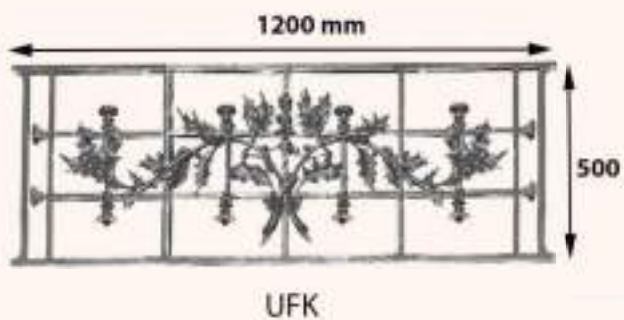
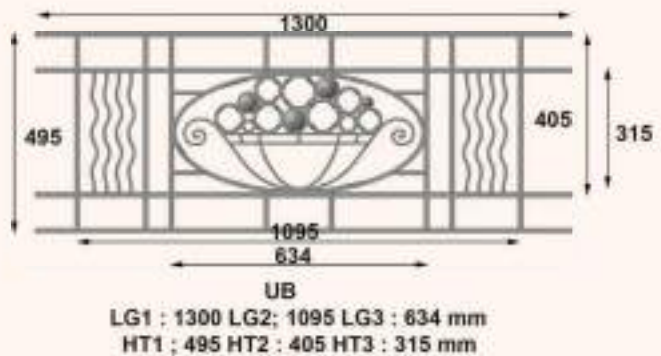
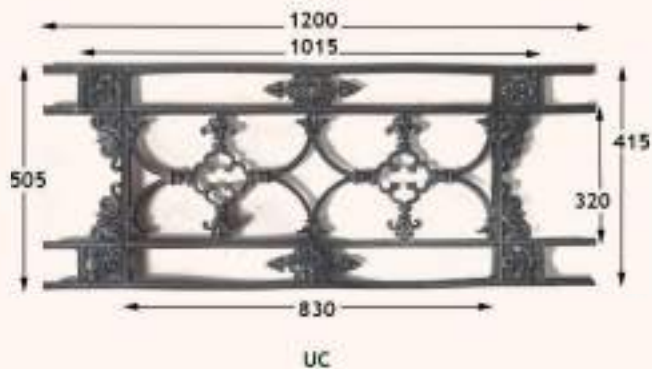
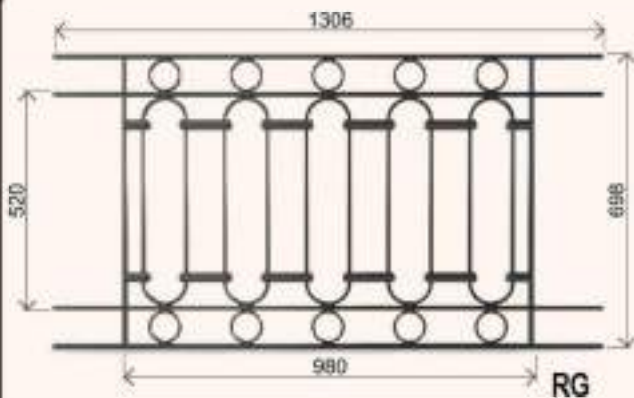

# LOISELET

Depuis 1850 à Nogent Le Roi Eure et Loir  
César Loiselet Créateur de l'industrie et de la fonte d'Art  
FONDERIE D'ART FONDERIE DE FONTE ET METALLIER

Eure et Loir Nogent Le Roi

65 rue du faubourg valmorin

## BALCONS DE CROISEES



UD  
LG1 : 1800mm LG2 : 1485mm LG3 : 1320mm  
HT1 : 445mm



UI  
HT1 : 620mm HT2 : 520mm HT3 : 410mm  
LG1 : 1290mm LG2 : 1090mm



UL  
HT1 : 555mm HT2 : 455mm HT3 : 360mm  
LG1 : 1140mm LG2 : 820mm



UM  
HT1 : 580mm HT2 : 490mm HT3 : 400mm  
LG1 : 1345mm LG2 : 1140mm LG3 : 1050mm



UK  
HT1 : 555mm HT2 : 455mm HT3 : 360mm  
LG1 : 1415mm LG2 : 1315mm LG3 : 990mm

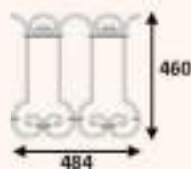
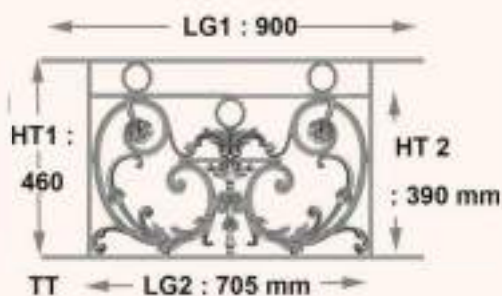

MODULE UR



# LOISELET

Depuis 1850 à Nogent Le Roi Eure et Loir  
César Loiselet Créateur de l'industrie et de la fonte d'Art  
FONDERIE D'ART FONDERIE DE FONTE ET METALLIER

Eure et Loir Nogent Le Roi

65 rue du faubourg valmorin

## BALCONS DE CROISEES



**US**

HT1 : 550mm HT2 : 470mm HT3 : 395mm  
LG1 : 1430mm LG2 : 1160mm LG3 : 890mm



**UU**

HT1 400mm HT2 330mm  
LG1 1350 mm LG2 1030 mm LG3 900mm



**YB**

haut : 450 mm  
long hors tout : 1300 mm  
long intérieur : 1100 mm

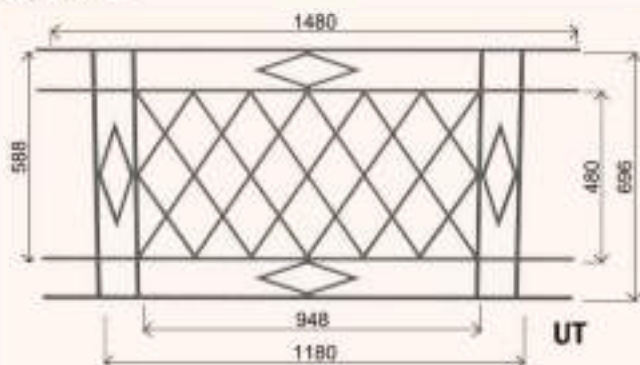

**WR**

HT1 600 mm HT2 500 mm HT3 400 mm  
LG1 1480 mm LG2 1280 mm

**YA**

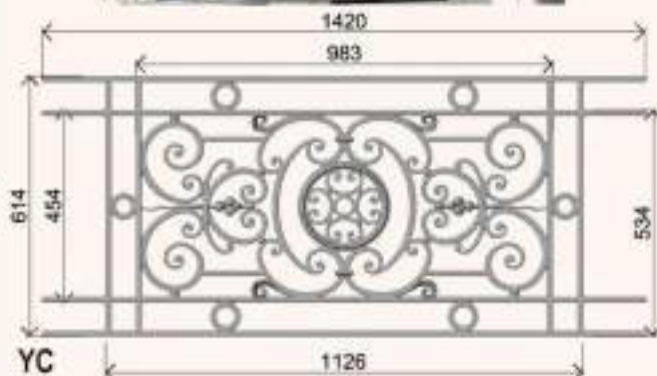
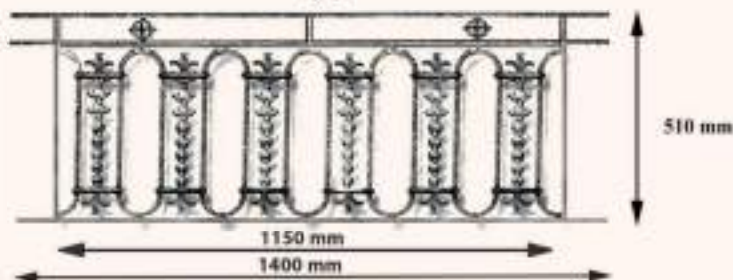

# LOISELET

Depuis 1850 à Nogent Le Roi Eure et Loir  
César Loiselet Créateur de l'industrie et de la fonte d'Art  
FONDERIE D'ART FONDERIE DE FONTE ET METALLIER

Eure et Loir Nogent Le Roi

65 rue du faubourg valmorin

## BALCONS DE CROISEES



**YD**  
HT1 : 445 mm  
LG1 : 1295 mm - LG2 : 995 mm

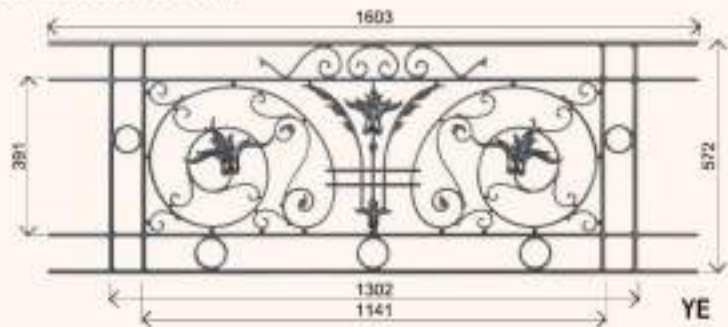

haut : 460 mm  
long hors tout : 1440 mm  
long intérieur : 1120 mm



**YG**  
HT1 : 560 mm - HT2 : 470 mm - HT3 : 380 mm  
LG1 : 1440 mm - LG2 : 1290 mm - LG3 : 1120 mm

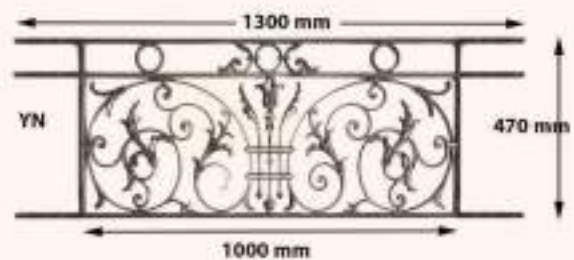

**YH**

**YG**

**YI**



75 \* 350 haut



150 \* 350 haut



**YJ**

520

415

463



réalisé en acier

**YK**

DIMENSIONS A LA DEMANDE

# LOISELET

Depuis 1850 à Nogent Le Roi Eure et Loir  
César Loiselet Créateur de l'industrie et de la fonte d'Art  
FONDERIE D'ART FONDERIE DE FONTE ET METALLIER

Eure et Loir Nogent Le Roi

65 rue du faubourg valmorin

## BALCONS DE CROISEES

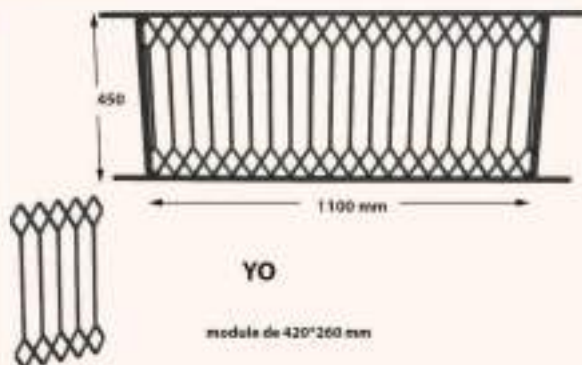
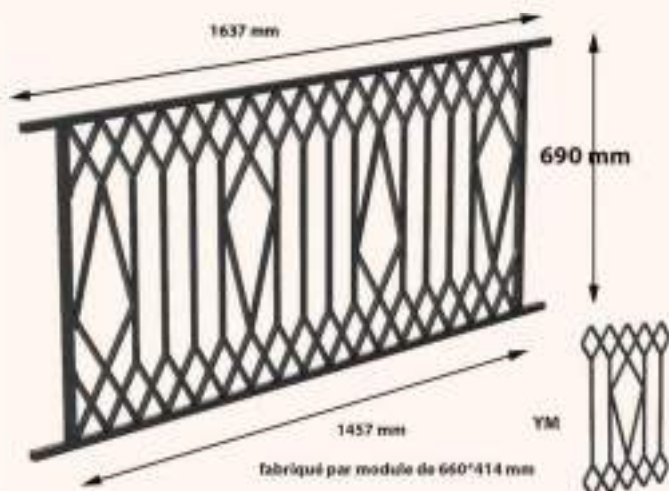

LG1 : 1540 mm LG2 : 1130 mm LG3 : 960 mm  
HT1 : 640 mm HT2 : 550 mm HT3 : 460 mm



HT1 505 mm  
HT2 430 mm  
HT3 340 mm

LG1 1580 mm  
LG2 1325 mm  
LG3 1155 mm

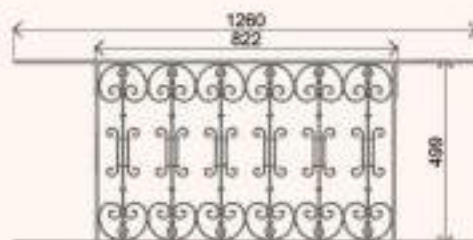

HT1 : 350 mm LG1 : 1500 mm LG2 : 1155 mm

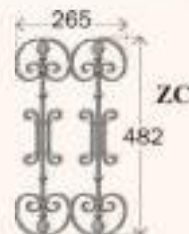

HT1 : 477 mm  
HT2 : 395 mm  
LG1 : 1068 mm  
LG2 : 850 mm



HT1 : 508 mm  
HT2 : 352 mm  
LG1 : 1245 mm  
LG2 : 952 mm

# LOISELET

Depuis 1850 à Nogent Le Roi Eure et Loir  
César Loiselet Créateur de l'industrie et de la fonte d'Art  
FONDERIE D'ART FONDERIE DE FONTE ET METALLIER

Eure et Loir Nogent Le Roi

65 rue du faubourg valmorin

## BALCONS DE CROISEES

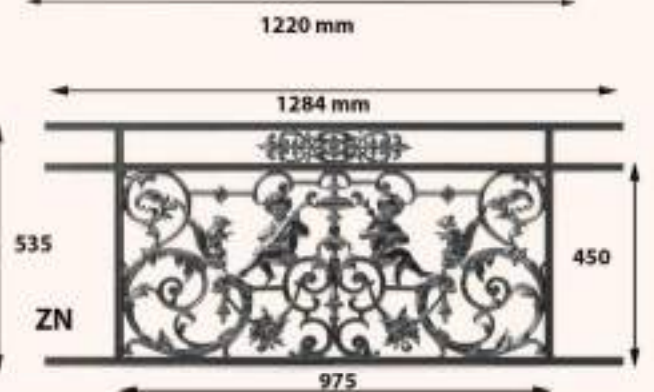
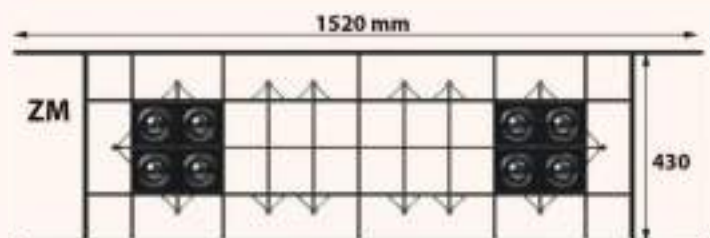
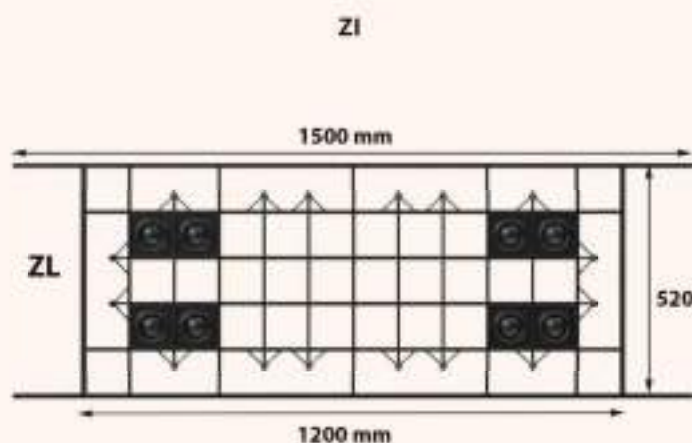
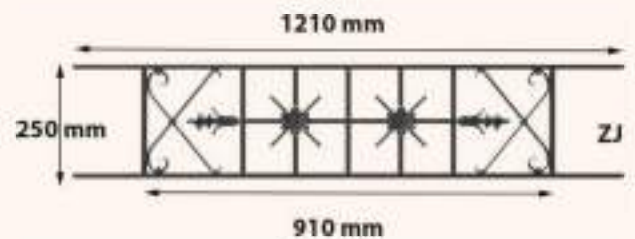
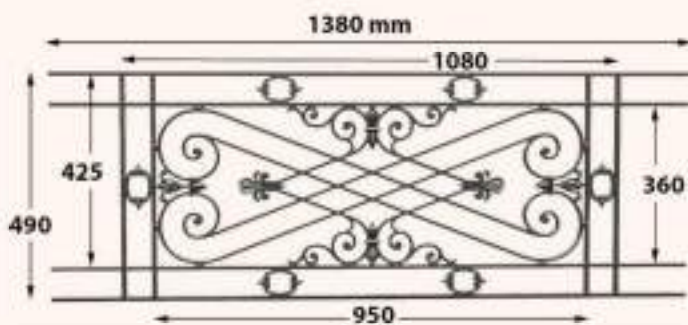
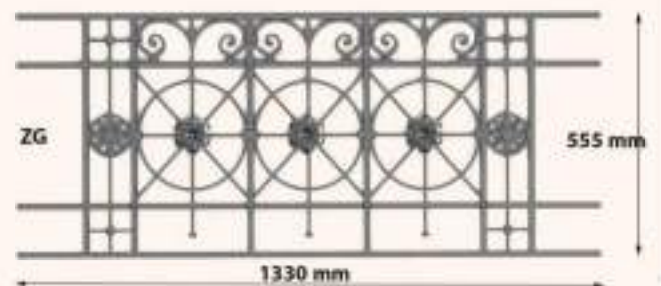
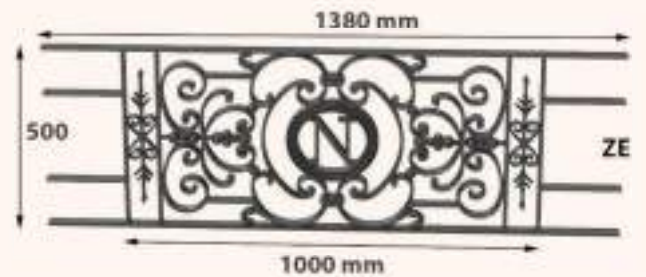
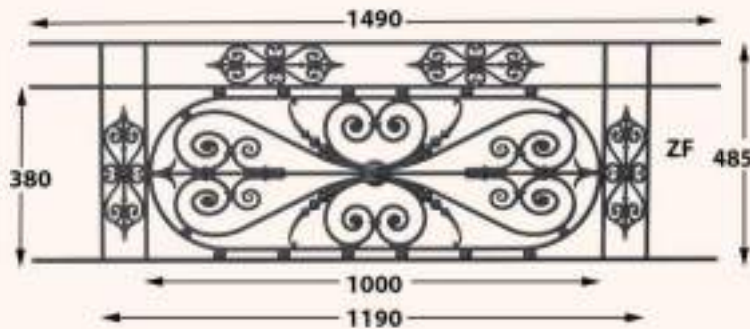

# LOISELET

Depuis 1850 à Nogent Le Roi Eure et Loir  
César Loiselet Créateur de l'industrie et de la fonte d'Art  
FONDERIE D'ART FONDERIE DE FONTE ET METALLIER

Eure et Loir Nogent Le Roi

65 rue du faubourg valmorin

## BALUSTRADES

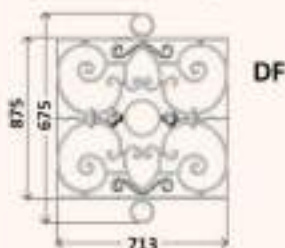
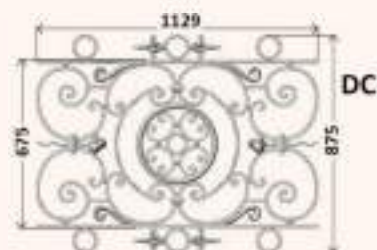

HD  
HT1 : 875mm  
LG1 : 200mm

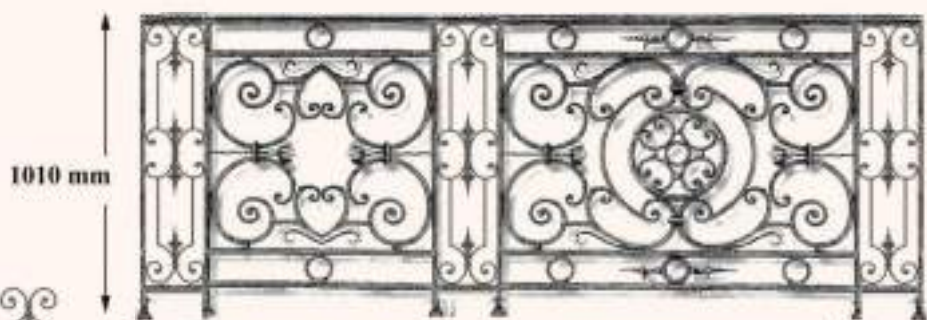

150mm



825\*190



825\*228



825\*385mm

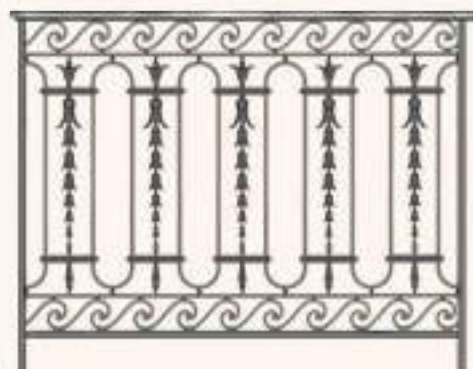

GB



870\*486

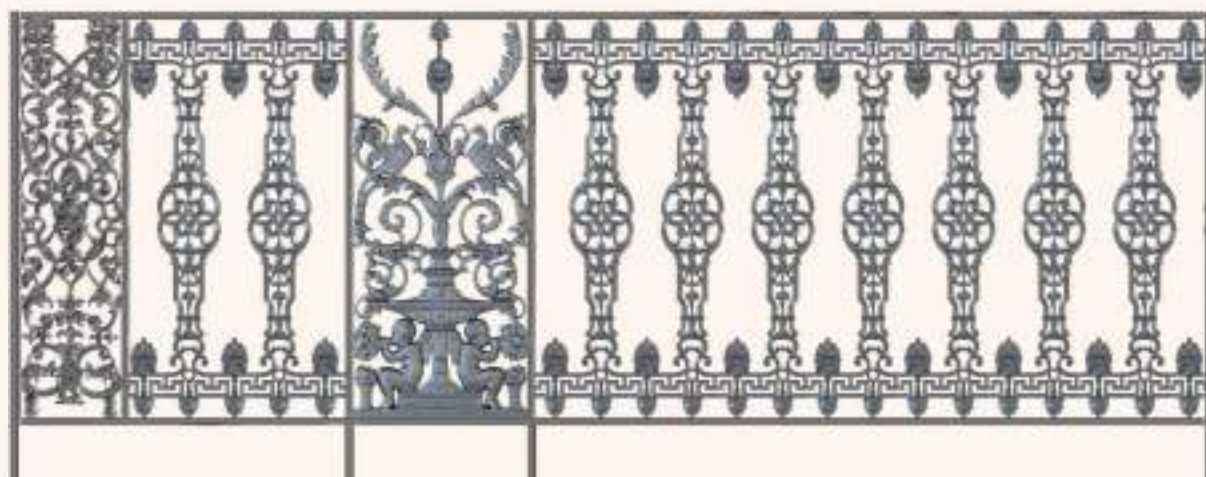

# LOISELET

Depuis 1850 à Nogent Le Roi Eure et Loir  
César Loiselet Créateur de l'industrie et de la fonte d'Art  
FONDERIE D'ART FONDERIE DE FONTE ET METALLIER

Eure et Loir Nogent Le Roi

65 rue du faubourg valmorin

## BALUSTRADES

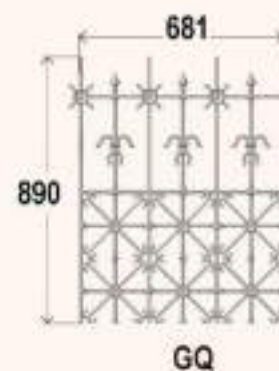
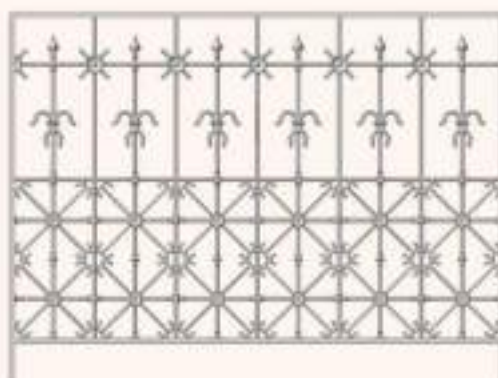
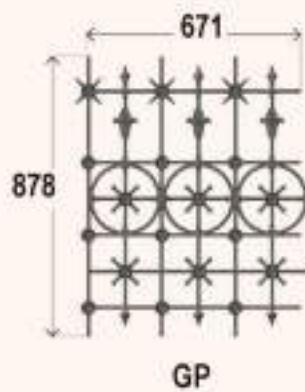
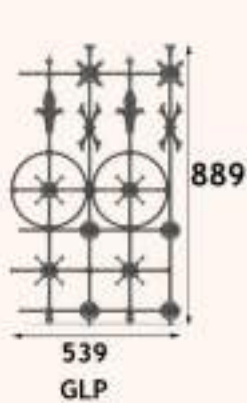
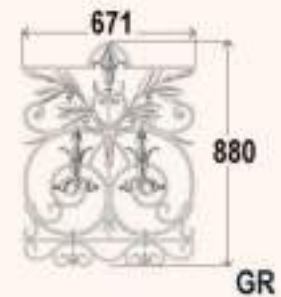
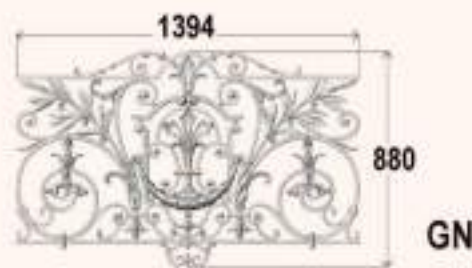
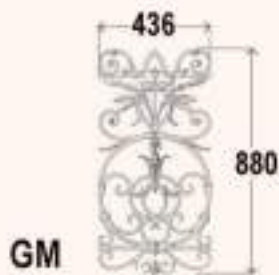

# LOISELET

Depuis 1850 à Nogent Le Roi Eure et Loir  
César Loiselet Créateur de l'industrie et de la fonte d'Art  
FONDERIE D'ART FONDERIE DE FONTE ET METALLIER

Eure et Loir Nogent Le Roi

65 rue du faubourg valmorin

## BALUSTRADES

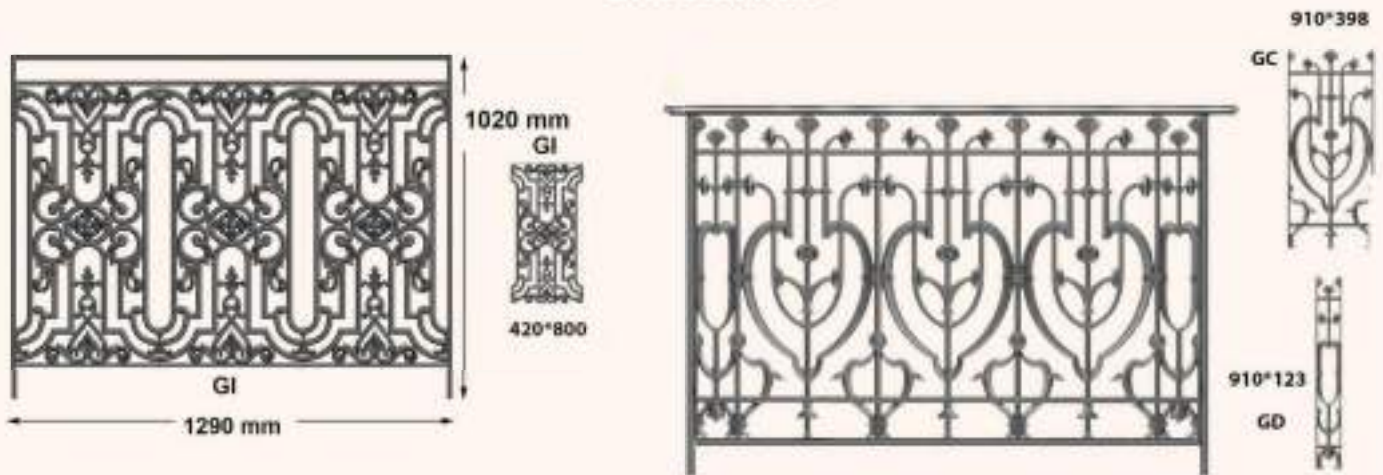

GK  
885\*555



GG  
885\*1320mm



GH  
885\*320



GJ  
885\*425

PWC

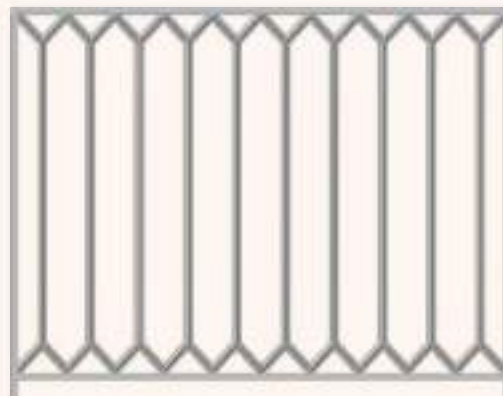
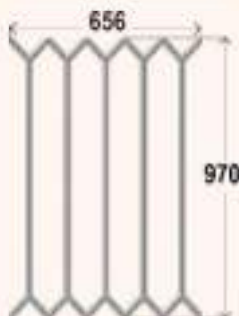

# LOISELET

Depuis 1850 à Nogent Le Roi Eure et Loir  
 César Loiselet Créateur de l'industrie et de la fonte d'Art  
**FONDERIE D'ART FONDERIE DE FONTE ET METALLIER**

Eure et Loir Nogent Le Roi

65 rue du faubourg valmorin

## BALUSTRADES

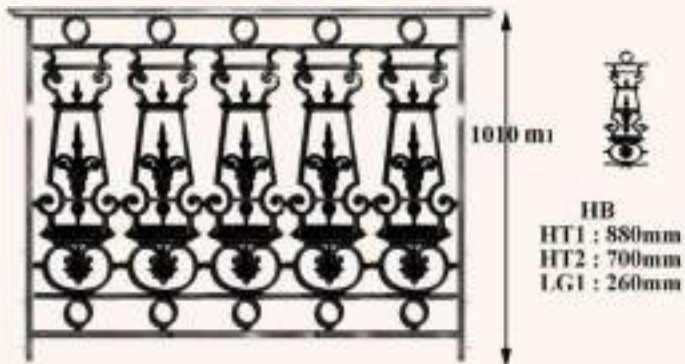
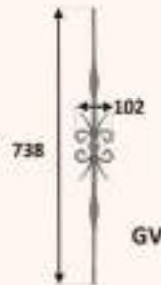
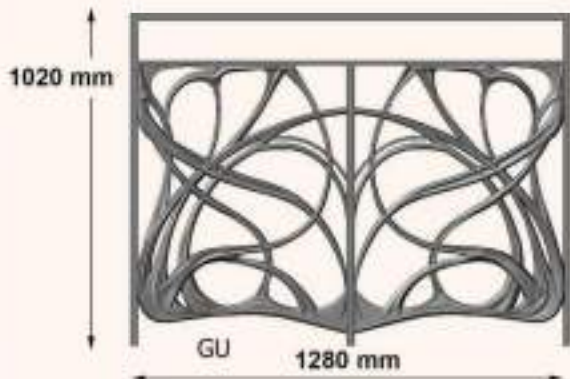



# LOISELET

Depuis 1850 à Nogent Le Roi Eure et Loir  
César Loiselet Créateur de l'industrie et de la fonte d'Art  
FONDERIE D'ART FONDERIE DE FONTE ET METALLIER

Eure et Loir Nogent Le Roi

65 rue du faubourg valmorin

## BALUSTRADES



HE

HT1 920mm HT2 820mm HT3 720mm HT4 620mm  
LG1 900mm LG2 850mm LG3 660mm



HL  
450\*880 mm



HI  
HT1 : 575mm  
LG1 : 450mm



HG  
HT1 : 865mm  
LG1 : 500mm

HJ  
HT1 : 870mm  
LG1 : 450mm

HN



HM 2440 mm

HO  
265 mm

1020 mm



# LOISELET

Depuis 1850 à Nogent Le Roi Eure et Loir  
César Loiselet Créateur de l'industrie et de la fonte d'Art  
FONDERIE D'ART FONDERIE DE FONTE ET METALLIER

Eure et Loir Nogent Le Roi

65 rue du faubourg valmorin

## BALUSTRADES

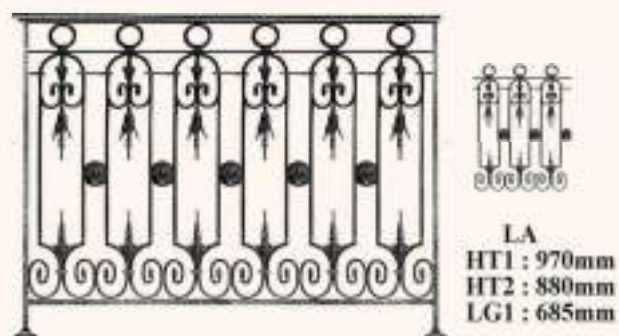
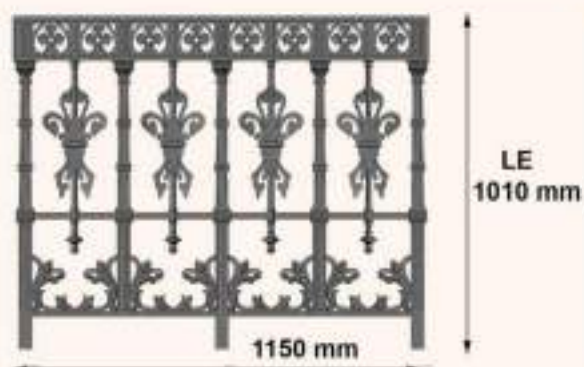
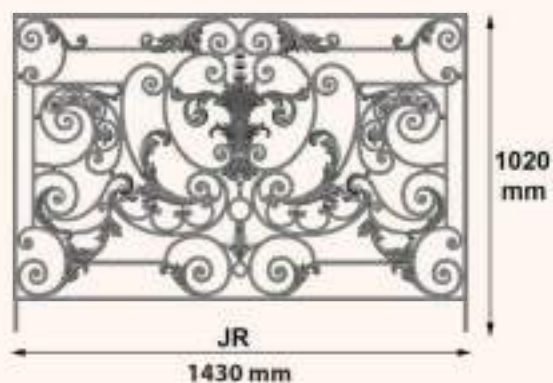
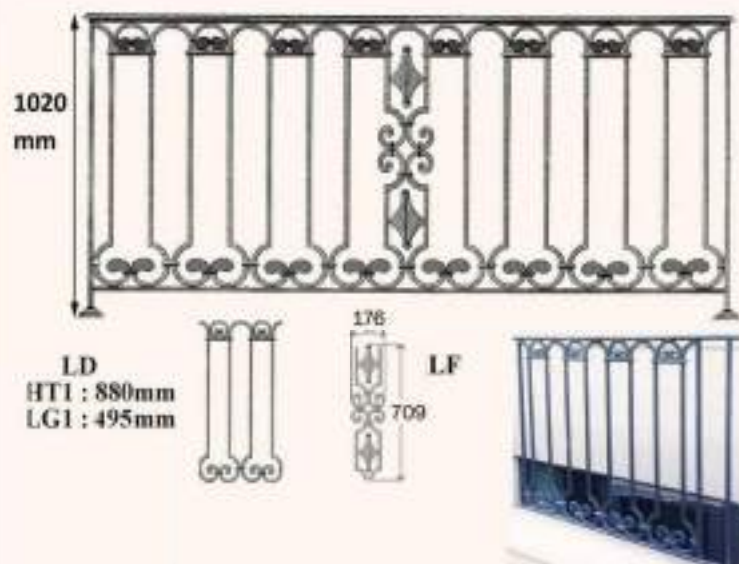
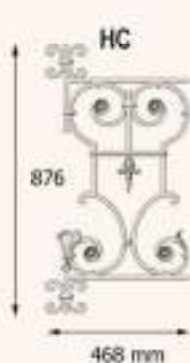
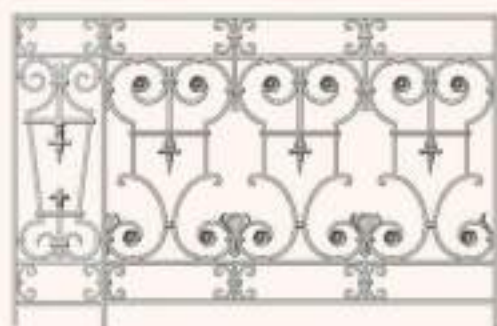

# LOISELET

Depuis 1850 à Nogent Le Roi Eure et Loir  
César Loiselet Créateur de l'industrie et de la fonte d'Art  
FONDERIE D'ART FONDERIE DE FONTE ET METALLIER

Eure et Loir Nogent Le Roi

65 rue du faubourg valmorin

## BALUSTRADES

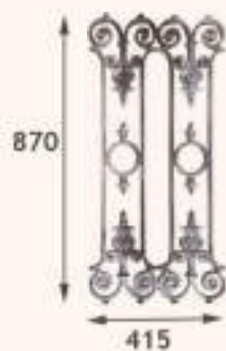
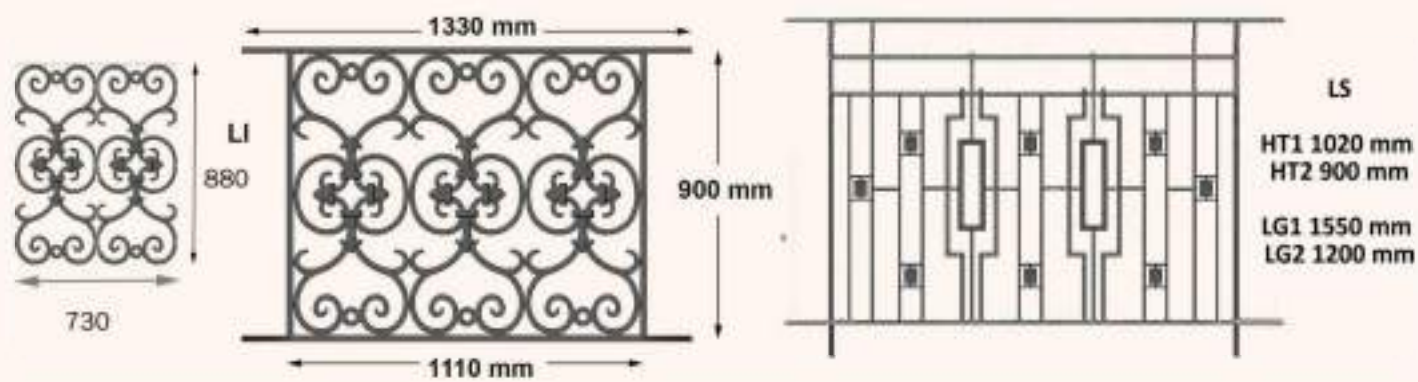

LCB

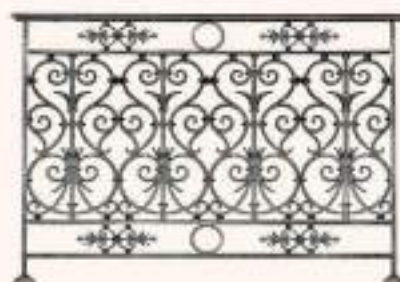

LCD

# LOISELET

Depuis 1850 à Nogent Le Roi Eure et Loir  
César Loiselet Créateur de l'industrie et de la fonte d'Art  
FONDERIE D'ART FONDERIE DE FONTE ET METALLIER

Eure et Loir Nogent Le Roi

65 rue du faubourg valmorin

## BALUSTRADES



OB  
HT1 : 905mm  
LG1 : 625mm



OA  
HT1 : 800mm  
LG1 : 1045mm

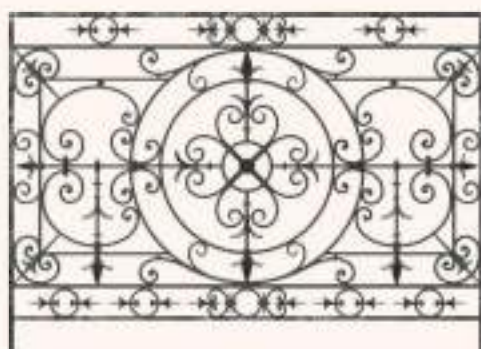

1010 mm

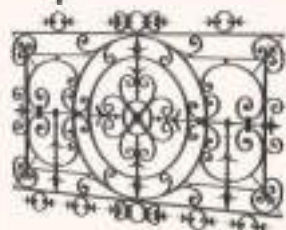

OD  
HT1 : 910 mm  
HT2 : 730 mm  
LG1 : 1415 mm

OC  
HT1 : 840mm  
NT2 : 670mm  
LG1 : 1600mm



OE

HT1 : 870mm  
HT2 : 700mm  
LG1 : 150mm



OI

HT1 : 870n  
HT2 : 700n  
LG1 : 400n



OF

HT1 : 870mm  
HT2 : 700mm  
LG1 : 350mm



OG

HT1 : 870mm  
HT2 : 700mm  
LG1 : 690mm



# LOISELET

Depuis 1850 à Nogent Le Roi Eure et Loir  
César Loiselet Créateur de l'industrie et de la fonte d'Art  
FONDERIE D'ART FONDERIE DE FONTE ET METALLIER

Eure et Loir Nogent Le Roi

65 rue du faubourg valmorin

## BALUSTRADES



OJ  
HT1 : 830mm  
LG1 : 560mm



OK  
HT1 : 830mm  
LG1 : 425mm

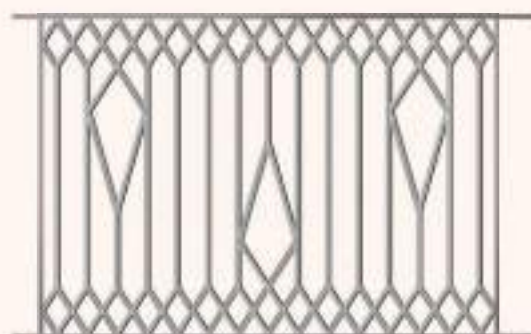

1900 mm  
OL Fabriqué par module de 880 de haut\*280

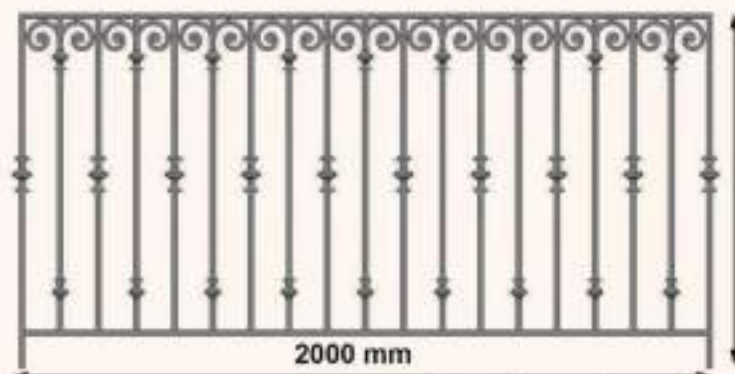

OX Largeur suivant demande

1020 mm

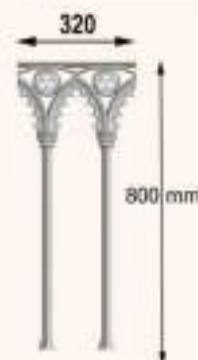

OS



OY Fabriqué par module de 880 de haut\* 465 mm



# LOISELET

Depuis 1850 à Nogent Le Roi Eure et Loir  
 César Loiselet Créateur de l'industrie et de la fonte d'Art  
 FONDERIE D'ART FONDERIE DE FONTE ET METALLIER

Eure et Loir Nogent Le Roi

65 rue du faubourg valmorin

## BALUSTRADES

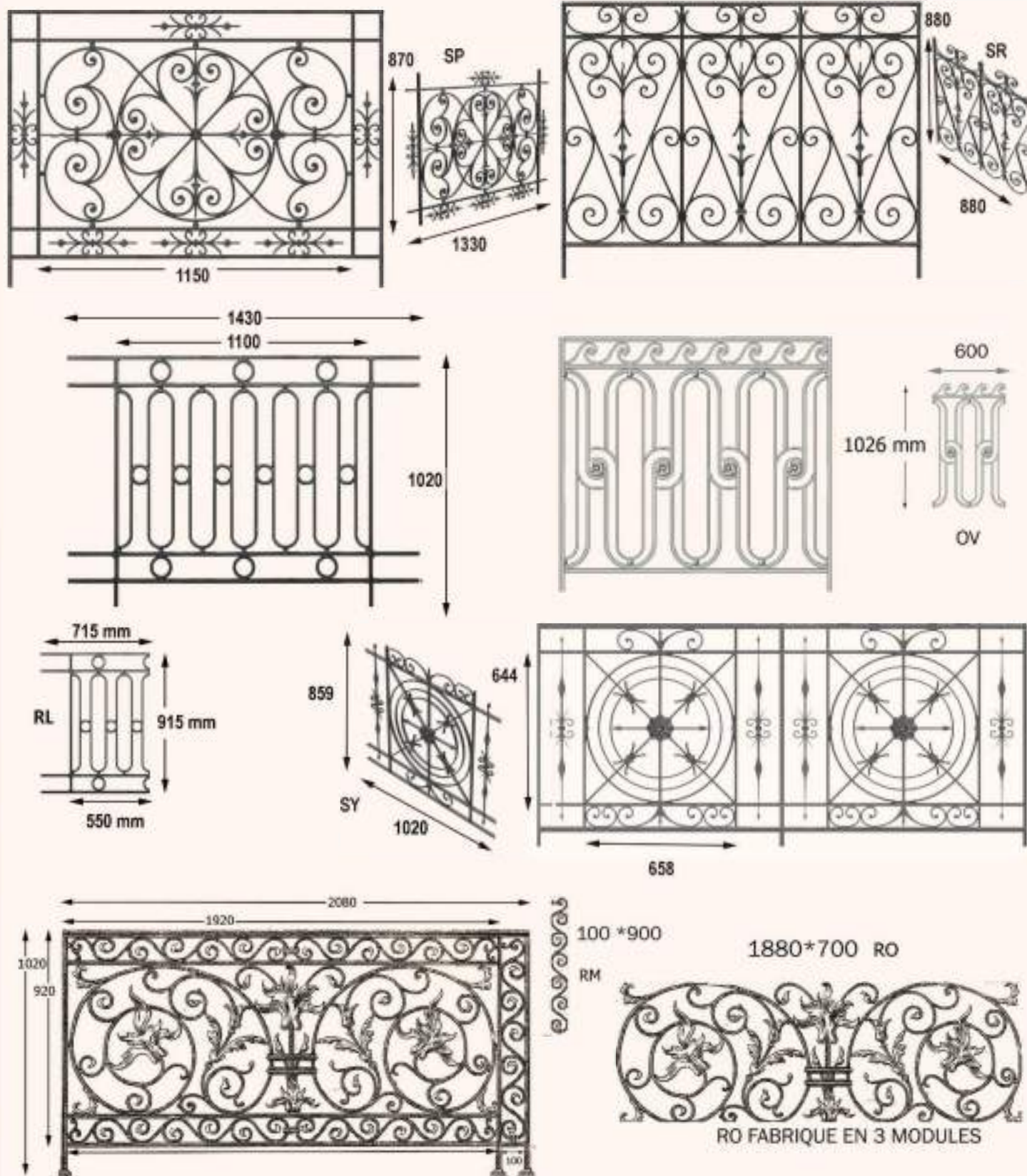

# LOISELET

Depuis 1850 à Nogent Le Roi Eure et Loir  
César Loiselet Créateur de l'industrie et de la fonte d'Art  
FONDERIE D'ART FONDERIE DE FONTE ET METALLIER

Eure et Loir Nogent Le Roi

65 rue du faubourg valmorin

## BALUSTRADES

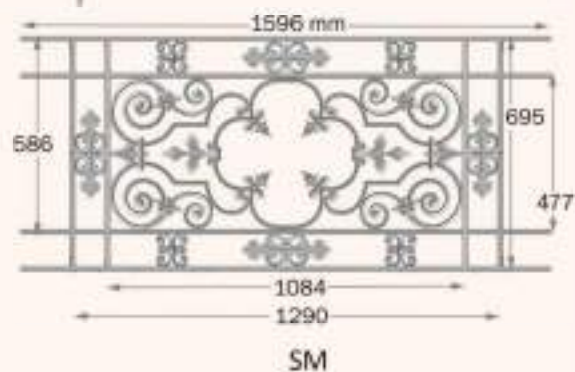
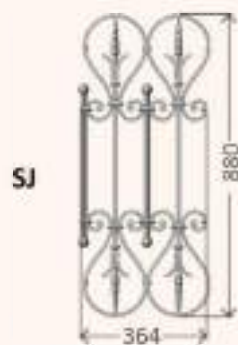
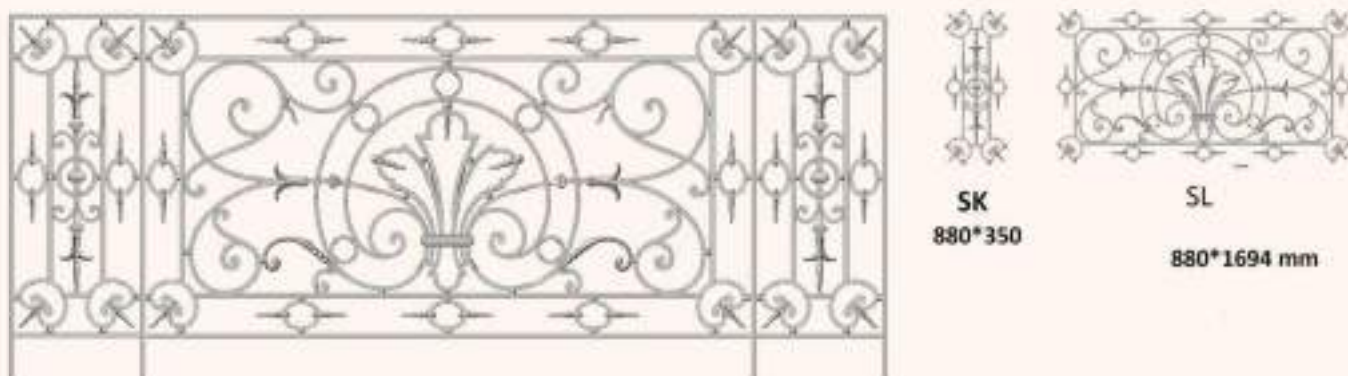

# LOISELET

Depuis 1850 à Nogent Le Roi Eure et Loir  
César Loiselet Créateur de l'industrie et de la fonte d'Art  
FONDERIE D'ART FONDERIE DE FONTE ET METALLIER

Eure et Loir Nogent Le Roi

65 rue du faubourg valmorin

## BALUSTRADES

réalisée en acier

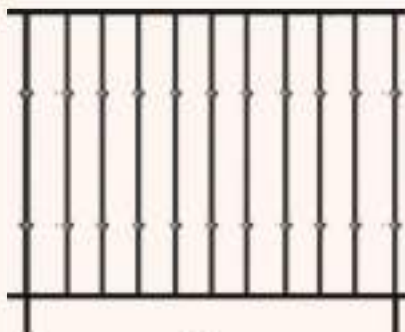

SI  
DIMENSIONS A LA DEMANDE



SH  
480\*880 mm

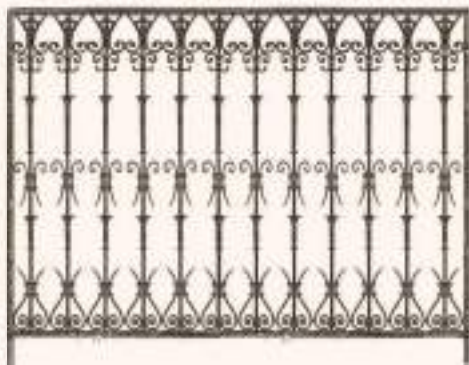

SG  
230\*870 mm

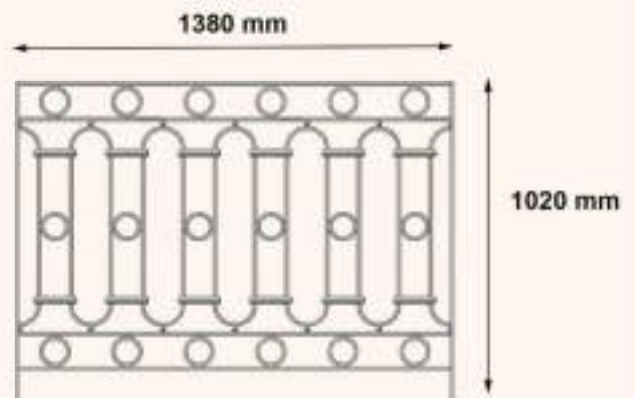

SZ

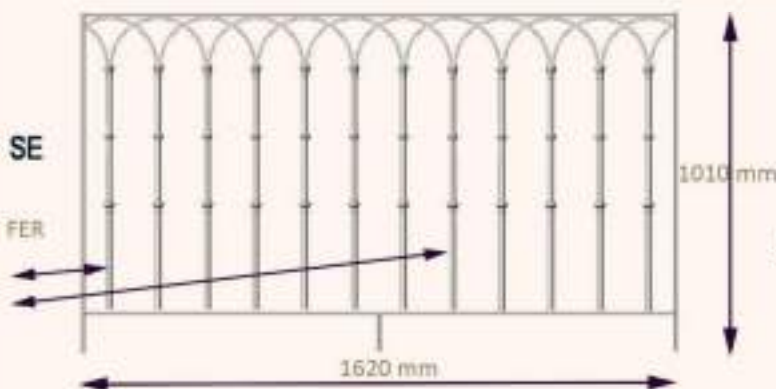

SE

FER

FONTE

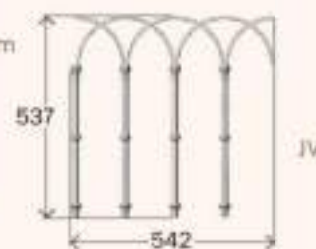

IV

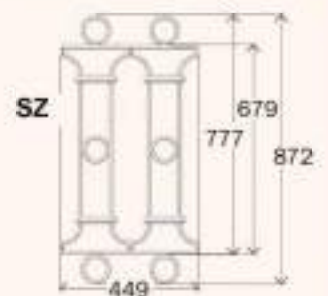

SZ

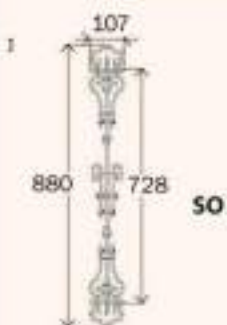

SO

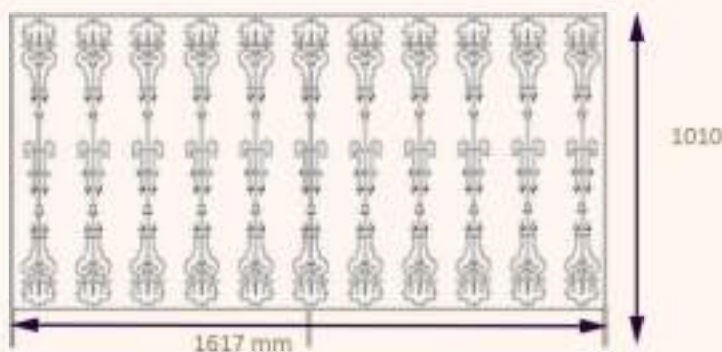

1010



CS30

CACHE SCELLEMENT



# LOISELET

Depuis 1850 à Nogent Le Roi Eure et Loir  
César Loiselet Créateur de l'industrie et de la fonte d'Art  
FONDERIE D'ART FONDERIE DE FONTE ET METALLIER

Eure et Loir Nogent Le Roi

65 rue du faubourg valmorin

## BALUSTRADES



SX



900 mm



SW



SV

880\*120



GAU85

87\*708



GAU 86

214\*770



GAU 84

168\*770



860

TA

437

531



926

TB



# LOISELET

Depuis 1850 à Nogent Le Roi Eure et Loir  
César Loiselet Créateur de l'industrie et de la fonte d'Art  
FONDERIE D'ART FONDERIE DE FONTE ET METALLIER

Eure et Loir Nogent Le Roi

65 rue du faubourg valmorin

## BALUSTRADES

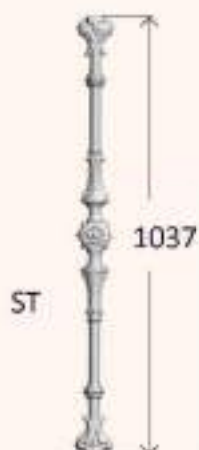

GAU 87  
520\*944

MINIMUM DE COMMANDE 40 PIECES



PLANCHE 42 COLLECTION LOISELET propriété de LOISELET reproduction interdite

COLLECTION REALISEE PAR Mlle Raymonde, Maud, M César, Henri, Albert, Jean, Yvon, François, Denis, Sylvain, Sébastien et Camille LOISELET

# LOISELET

Depuis 1850 à Nogent Le Roi Eure et Loir  
César Loiselet Créateur de l'industrie et de la fonte d'Art  
FONDERIE D'ART FONDERIE DE FONTE ET METALLIER

Eure et Loir Nogent Le Roi

65 rue du faubourg valmorin

## BALUSTRADES

MINIMUM DE COMMANDE 40 PIECES

h : 880 / 1100 mm  
a : 880 / 1100 mm



MINIMUM DE COMMANDE 40 PIECES



MINIMUM DE COMMANDE 40 PIECES



# LOISELET

Depuis 1850 à Nogent Le Roi Eure et Loir  
César Loiselet Créateur de l'industrie et de la fonte d'Art  
FONDERIE D'ART FONDERIE DE FONTE ET METALLIER

Eure et Loir Nogent Le Roi

65 rue du faubourg valmorin

## BALUSTRADES

h : 880 / 1100 mm  
a : 880 / 1100 mm

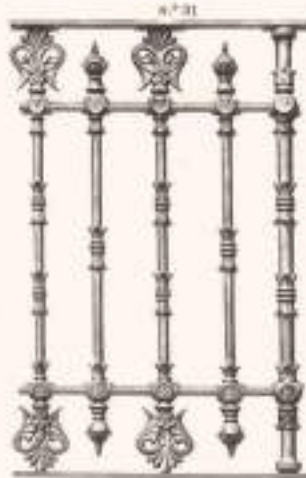

MINIMUM DE COMMANDE 40 PIECES



MINIMUM DE COMMANDE 40 PIECES

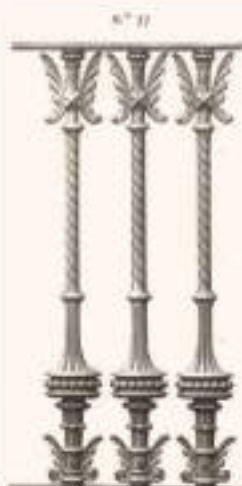

# LOISELET

Depuis 1850 à Nogent Le Roi Eure et Loir  
César Loiselet Créateur de l'industrie et de la fonte d'Art  
FONDERIE D'ART FONDERIE DE FONTE ET METALLIER

Eure et Loir Nogent Le Roi

65 rue du faubourg valmorin

## BALUSTRADES DE PONT



TETE DE PONT



402  
H200 D213

TE



EXTREMITE

TD



INTERMEDIAIRE

TK

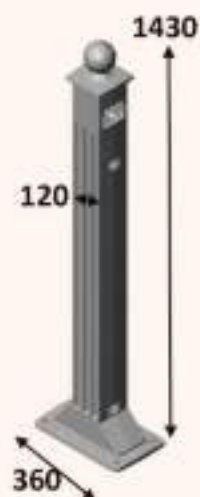

GW

TG



L 1075mm  
H 860 mm

1245



TLP

# LOISELET

Depuis 1850 à Nogent Le Roi Eure et Loir  
César Loiselet Créateur de l'industrie et de la fonte d'Art  
FONDERIE D'ART FONDERIE DE FONTE ET METALLIER

Eure et Loir Nogent Le Roi

65 rue du faubourg valmorin

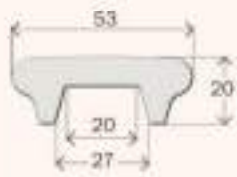

**MAIN COURANTE  
FONTE**



## MAIN COURANTE



main courante  
fonte 1400 mm

main courante bois  
sculptée ref 580  
h 34\*50\*2400  
h24\*50\*3000



**MAIN COURANTE FER  
MOULUREE**  
11\*40\*6000 mm  
12\*45\*6000 mm



**MAIN COURANTE FER**



**MAIN COURANTE FER  
DEMI ROND**  
16\*8\*3000 mm

## PATTES DE SCELLEMENT

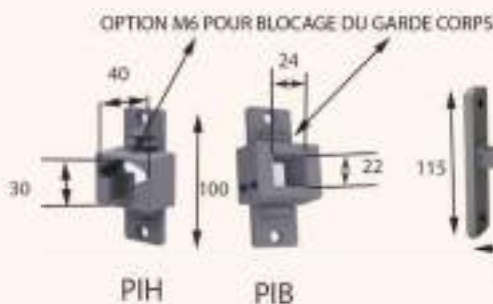

PIH

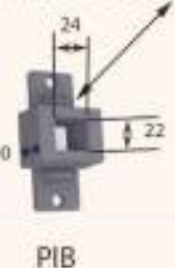

PIB



PEG



PED

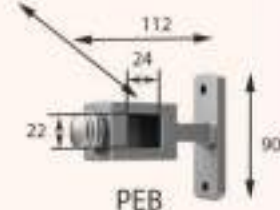

PEB

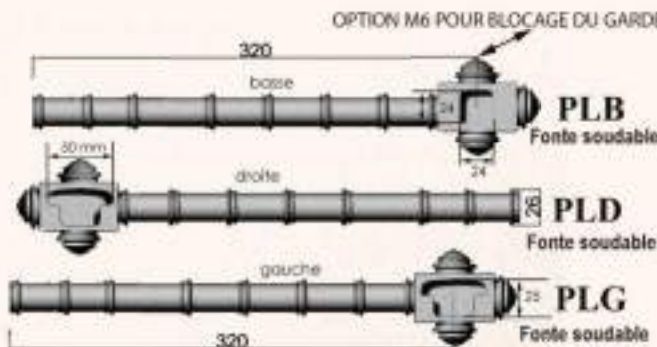

PLB

Fonte soudable

PLD

Fonte soudable

PLG

Fonte soudable

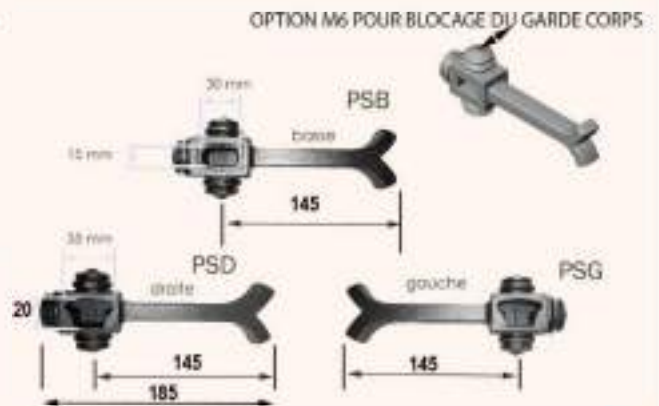

PSB

Fonte soudable

PSD

Fonte soudable

PSG

Fonte soudable



PMG

Fonte soudable

PMD

Fonte soudable

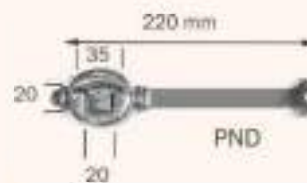

PND

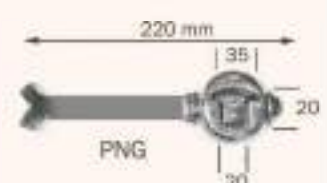

PNG



PNB

## PATTES A VISSER

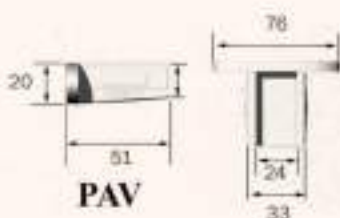

PAV

PIECES EN FONTE ET FER FORGE POUR COMPOSER PORTAIL.  
GARDE CORPS BALUSTRADE RAMPE D'ESCALIER



195  
430\*120 mm



196  
340\*120 mm



720  
h210 l 220



721  
h210 l 220



151  
360\*100

152  
360\*100

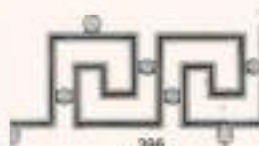

996  
390\*200 mm



723  
120 mm



710  
532\*126mm



724  
H 200



725  
H 200



712  
125\*125



711  
1020\*116



168  
120\*355 mm



127  
258\*80

128  
258\*80



132  
190\*95

131  
190\*95



700  
216\*78 mm



160  
340\*120



192  
480\*120 mm



714  
170\*219



162  
500\*200 mm



135  
115\*270

136  
115\*270



320  
285\*120 mm



715  
557\*114



319  
175\*240 mm



170  
180\*120 mm



702  
159\*108 mm



705  
165\*120



701  
125\*180 mm

# LOISELET

Depuis 1850 à Nogent Le Roi Eure et Loir  
César Loiselet Créateur de l'industrie et de la fonte d'Art  
FONDERIE D'ART FONDERIE DE FONTE ET METALLIER

Eure et Loir Nogent Le Roi

65 rue du faubourg valmorin

## PIECES EN FONTE ET FER FORGE POUR COMPOSER PORTAIL . GARDE CORPS BALUSTRADE RAMPE D'ESCALIER



522  
170\*350 mm



162  
120\*250 mm



593  
190\*95 mm



703  
185\*138 mm



175  
265\*275



318  
120\*75 mm



604  
120\*250 mm



191  
120\*185 mm



199  
215\*350 mm



199  
180\*120 mm



704  
240\*110 mm



321  
150\*150



196  
190\*100



190  
370\*320 mm



388  
180\*130 mm



376  
380\*205 mm



163  
240\*70



706  
145\*125



161  
240\*115



383  
235\*235 mm



# LOISELET

Depuis 1850 à Nogent Le Roi Eure et Loir  
César Loiselet Créateur de l'industrie et de la fonte d'Art  
FONDERIE D'ART FONDERIE DE FONTE ET METALLIER

Eure et Loir Nogent Le Roi

65 rue du faubourg valmorin

## PALMETTE ROSACES POUR PORTAIL EN FONTE ET FER FORGE



158  
400\*210



370  
405\*175



373  
650\*260



121  
235\*80



REF 1821  
400\*200mm



530  
210\*410



651  
230\*400



147  
150\*300



597  
220\*380



652  
210\*380



165  
530\*250



529  
580\*225

# LOISELET

Depuis 1850 à Nogent Le Roi Eure et Loir  
César Loiselet Créateur de l'industrie et de la fonte d'Art  
FONDERIE D'ART FONDERIE DE FONTE ET METALLIER

Eure et Loir Nogent Le Roi

65 rue du faubourg valmorin

## GARNITURE DE RAMPE D'ESCALIER POUR BARREAUX EN FER PLEIN

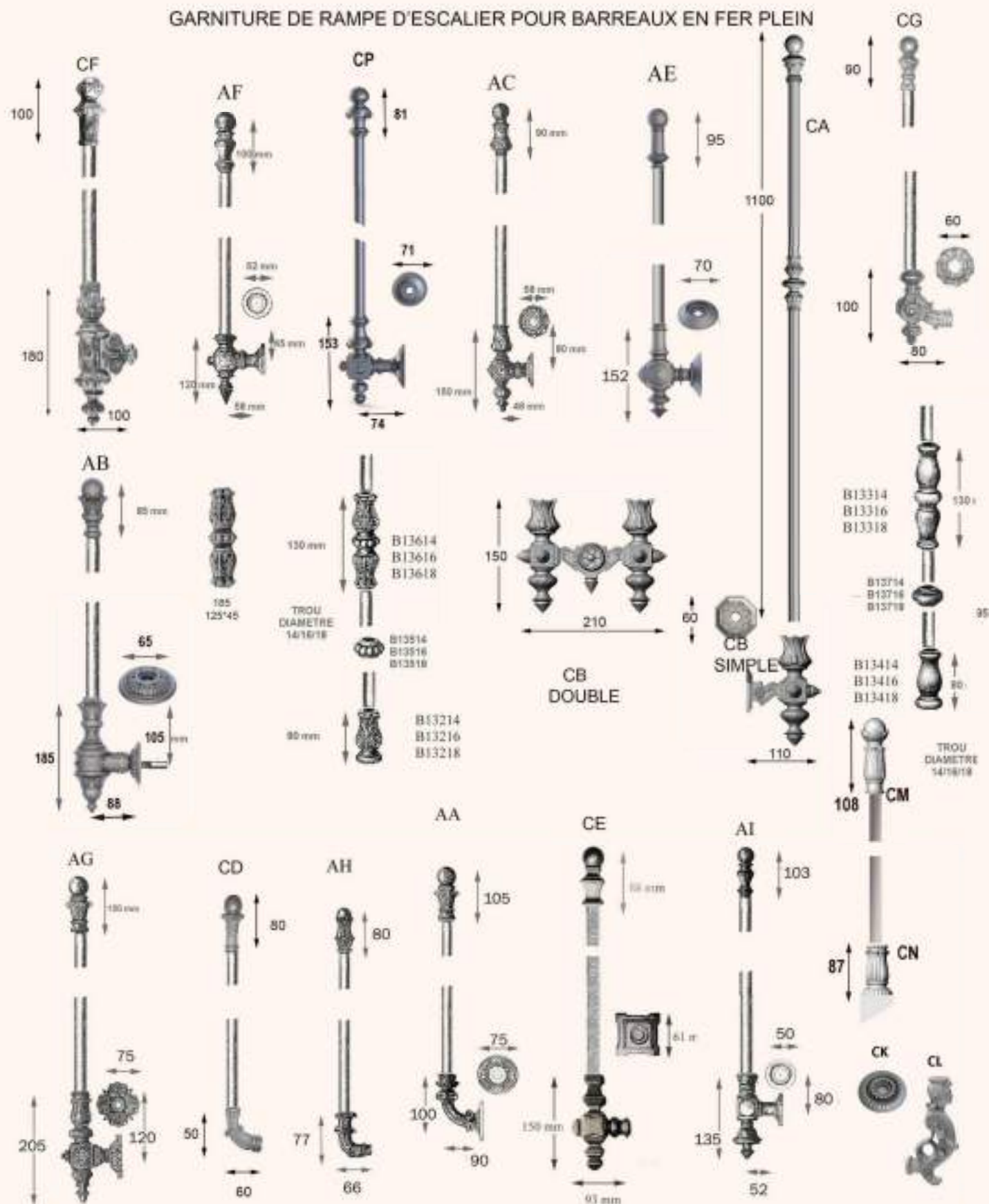

# LOISELET

Depuis 1850 à Nogent Le Roi Eure et Loir  
César Loiselet Créateur de l'industrie et de la fonte d'Art  
FONDERIE D'ART FONDERIE DE FONTE ET METALLIER

Eure et Loir Nogent Le Roi

65 rue du faubourg valmorin

## BARREAUX D'ESCALIER



Mise en conformité  
des barreaux d'escalier



poteau ref 434

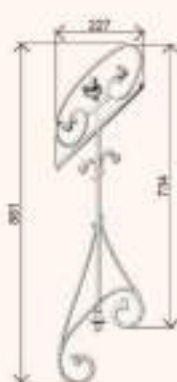

TJ

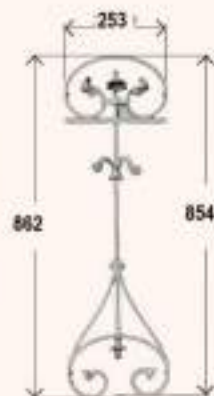

TK



TL



P8

# LOISELET

Depuis 1850 à Nogent Le Roi Eure et Loir  
César Loiselet Créateur de l'industrie et de la fonte d'Art  
FONDERIE D'ART FONDERIE DE FONTE ET METALLIER

Eure et Loir Nogent Le Roi

65 rue du faubourg valmorin

## PIECE EN FONTE POUR SERRE DE JARDIN

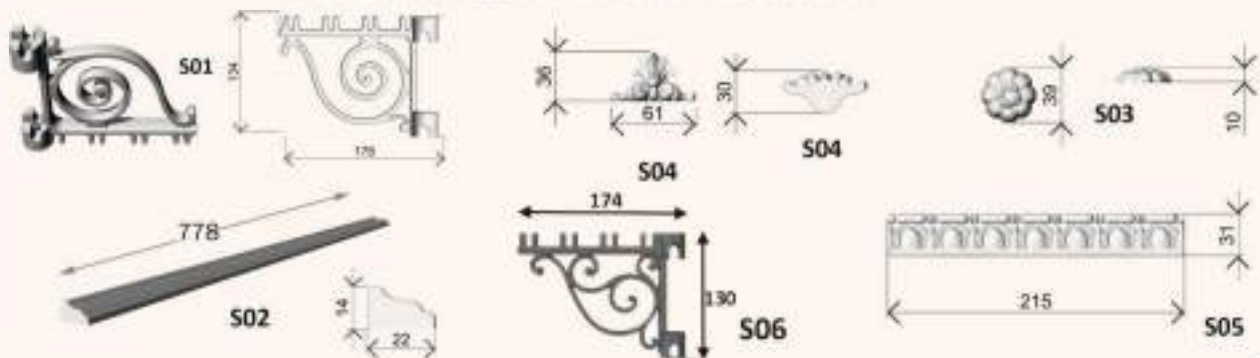

## BARREAU D'ESCALIER FONTE

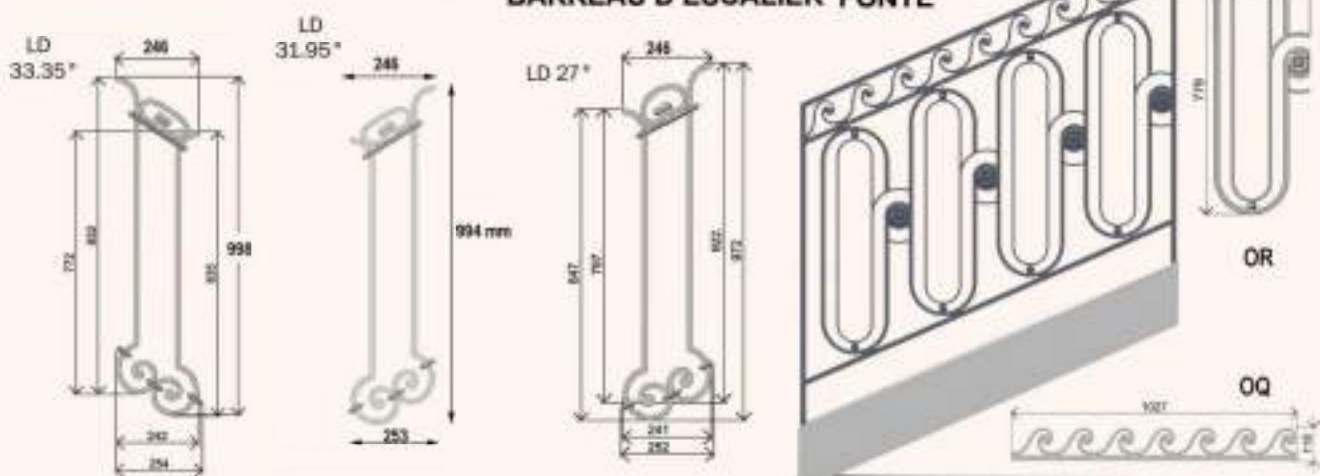

## BARREAU D'ESCALIER et BARREAU BALUSTRADE , GARDE CORPS FONTE ET FER FORGE

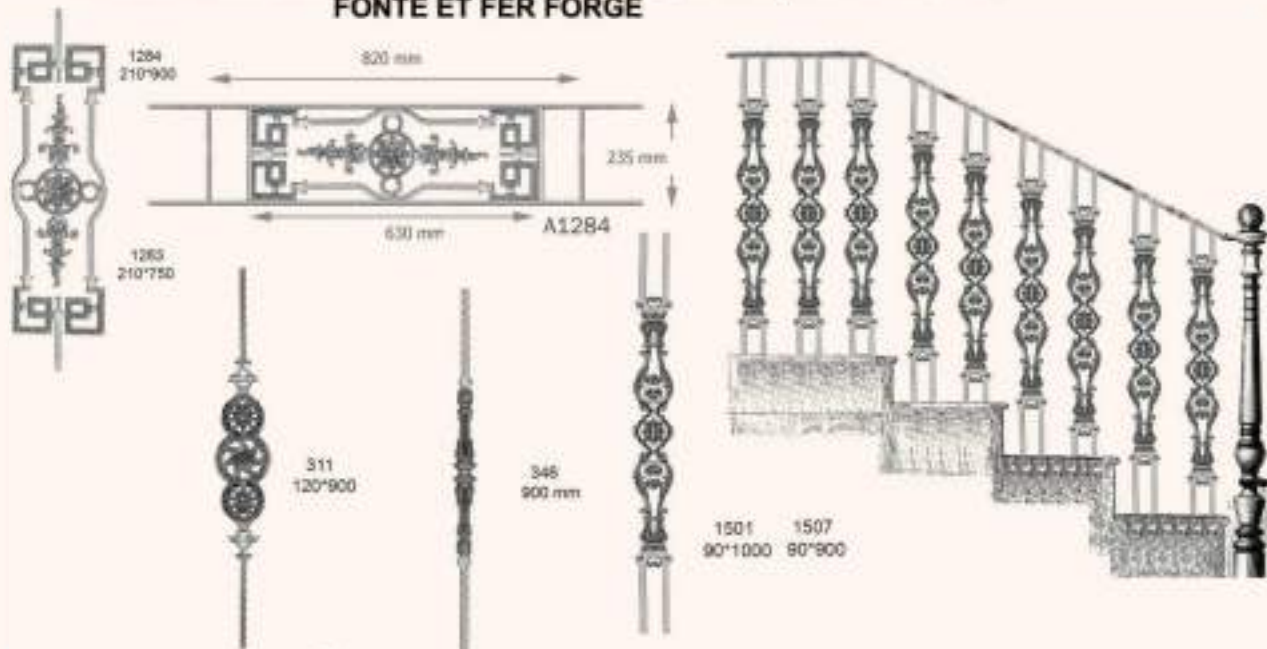

**BARREAU D'ESCALIER et BARREAU BALUSTRADE, GARDE CORPS  
 FONTE ET FER FORGE**



1279  
210\*900



402  
900 mm



1505  
220\*900



416  
900 mm



269  
390\*1200



437  
900mm



438  
900 mm



439  
900mm



461  
900mm



374  
440\*120



351  
230\*900

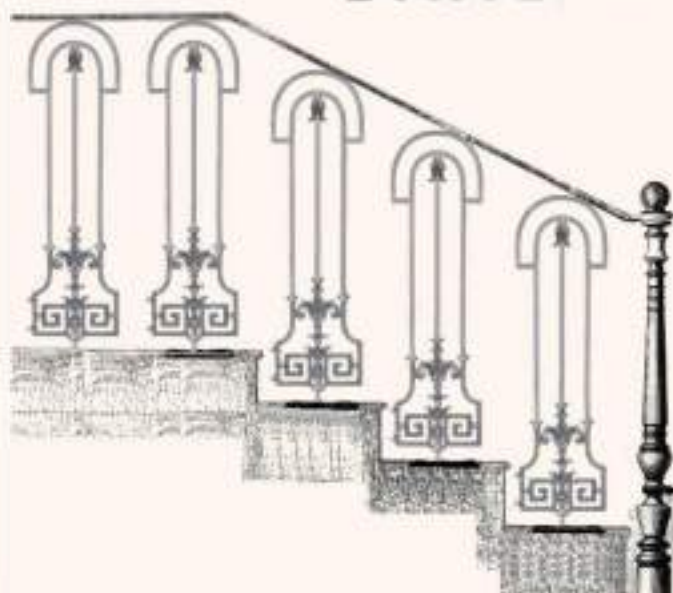

465  
900mm



378  
280\*750

# LOISELET

Depuis 1850 à Nogent Le Roi Eure et Loir  
 César Loiselet Créateur de l'industrie et de la fonte d'Art  
**FONDERIE D'ART FONDERIE DE FONTE ET METALLIER**

Eure et Loir Nogent Le Roi

65 rue du faubourg valmorin

## BARREAU D'ESCALIER et BARREAU BALUSTRADE, GARDE CORPS FONTE ET FER FORGE

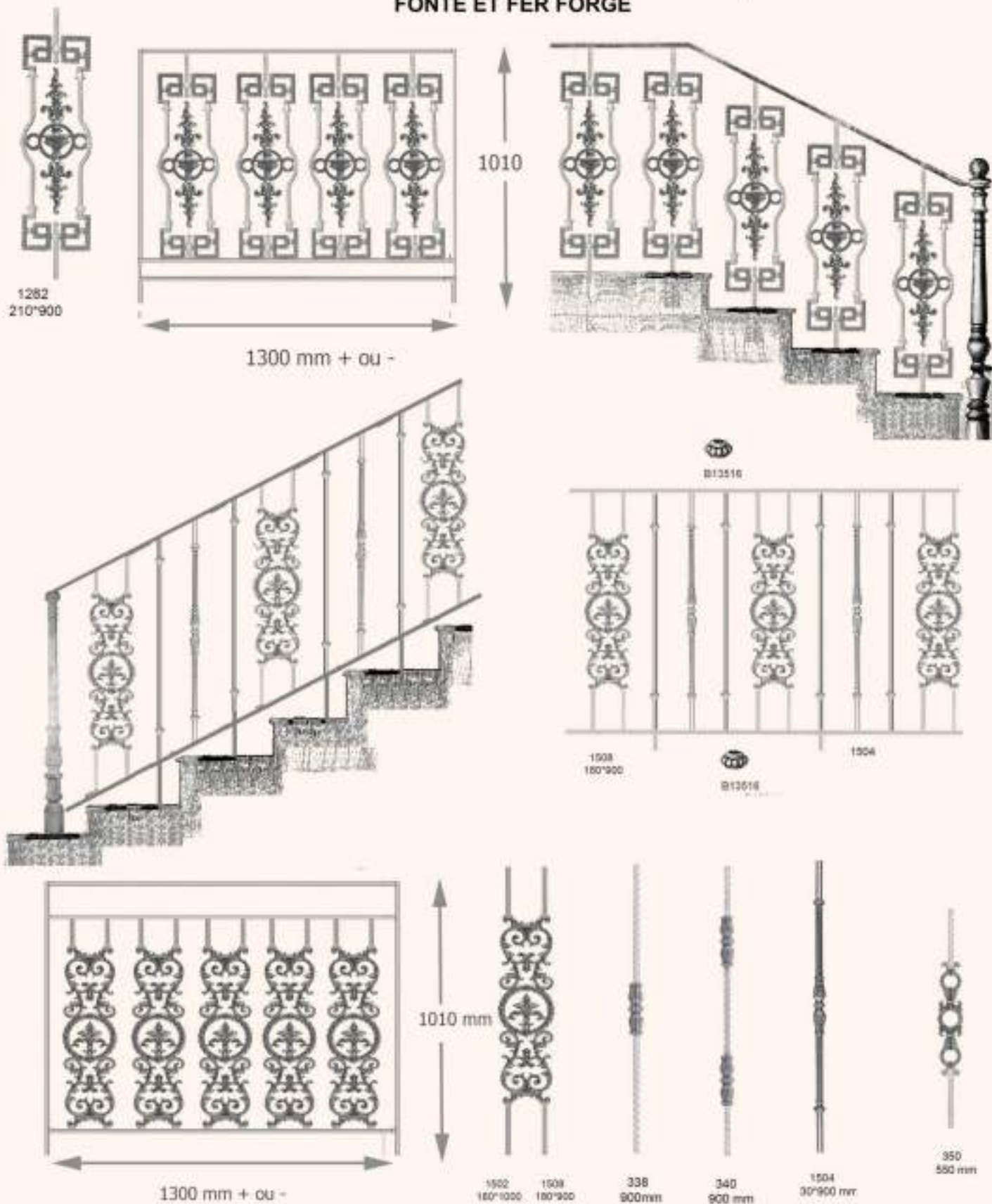

# LOISELET

Depuis 1850 à Nogent Le Roi Eure et Loir  
César Loiselet Créateur de l'industrie et de la fonte d'Art  
FONDERIE D'ART FONDERIE DE FONTE ET METALLIER

Eure et Loir Nogent Le Roi

65 rue du faubourg valmorin

## BARREAU D'ESCALIER et BARREAU BALUSTRADE, GARDE CORPS FONTE ET FER FORGE

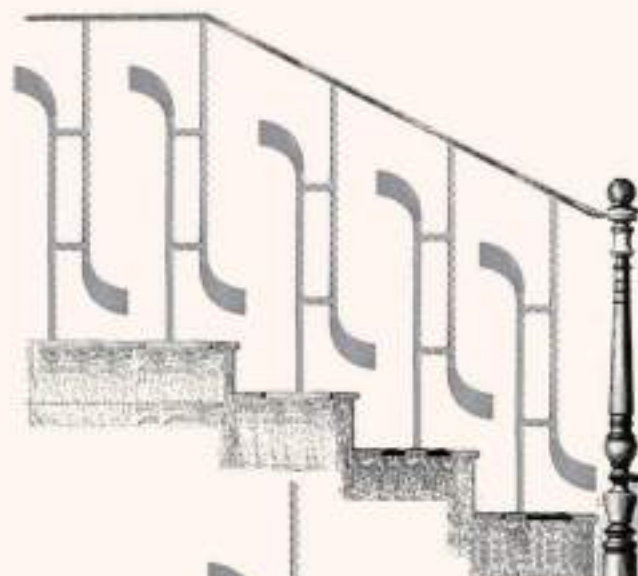
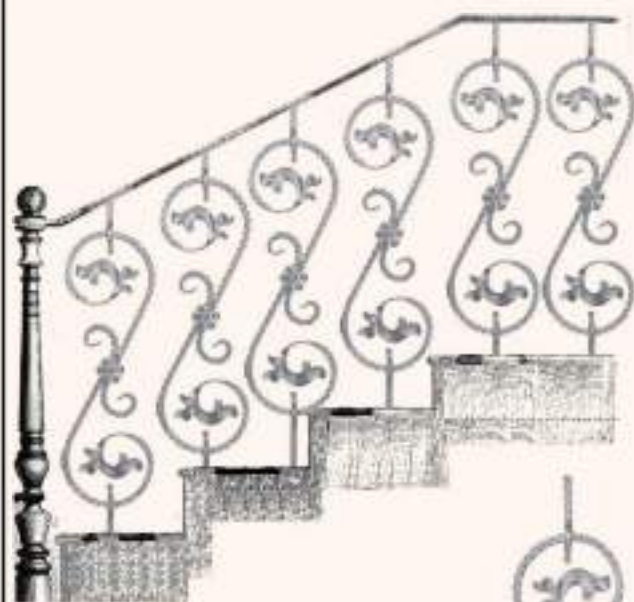

919  
350\*900



239  
185\*900



348  
900mm



331  
900mm



1211  
150\*900



1197  
300\*900



PLANCHE 55 COLLECTION LOISELET propriété de LOISELET reproduction interdite

COLLECTION REALISEE PAR M<sup>l</sup> Raymond, M<sup>l</sup> Maud, M César, Henri, Albert, Jean, Yvon, François, Denis, Sylvain, Sébastien et Camille LOISELET

# LOISELET

Depuis 1850 à Nogent Le Roi Eure et Loir  
César Loiselet Créateur de l'industrie et de la fonte d'Art  
FONDERIE D'ART FONDERIE DE FONTE ET METALLIER

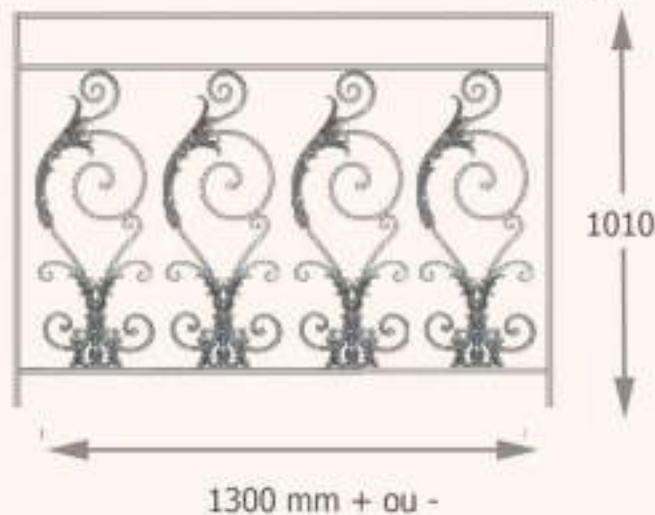
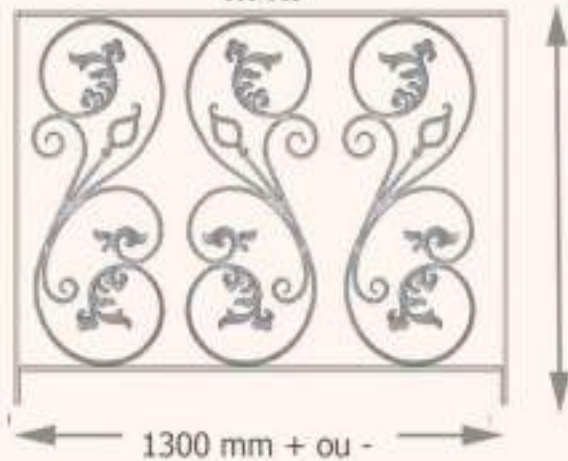
Eure et Loir Nogent Le Roi

65 rue du faubourg valmorin

## BARREAU D'ESCALIER et BARREAU BALUSTRADE, GARDE CORPS FONTE ET FER FORGE

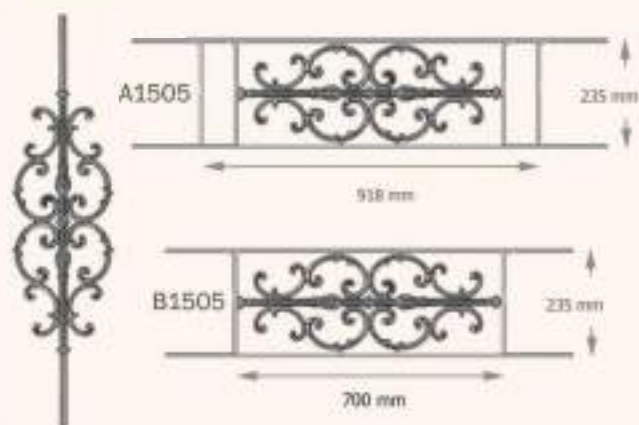

1505  
220\*900

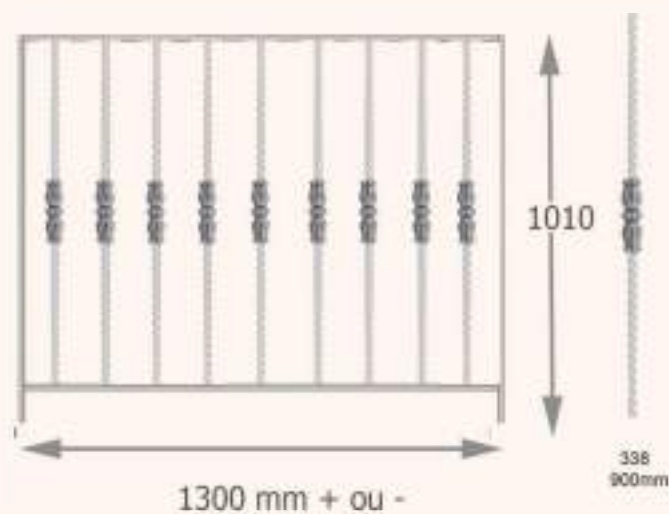

38  
900mm

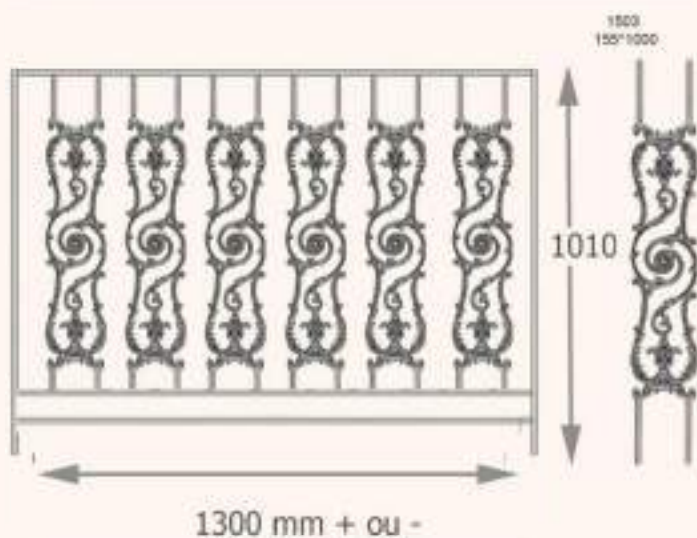

1500  
150\*1000

1010

1300 mm + ou -

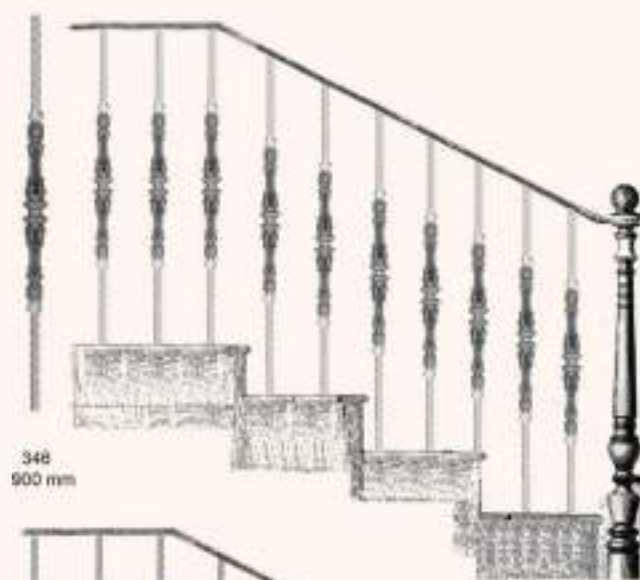

38  
900 mm



1201  
225\*900



1203  
310\*900



484  
900mm





# LOISELET

Depuis 1850 à Nogent Le Roi Eure et Loir  
César Loiselet Créateur de l'industrie et de la fonte d'Art  
FONDERIE D'ART FONDERIE DE FONTE ET METALLIER

Eure et Loir Nogent Le Roi

65 rue du faubourg valmorin

## BARREAU D'ESCALIER et BARREAU BALUSTRADE, GARDE CORPS FONTE ET FER FORGE

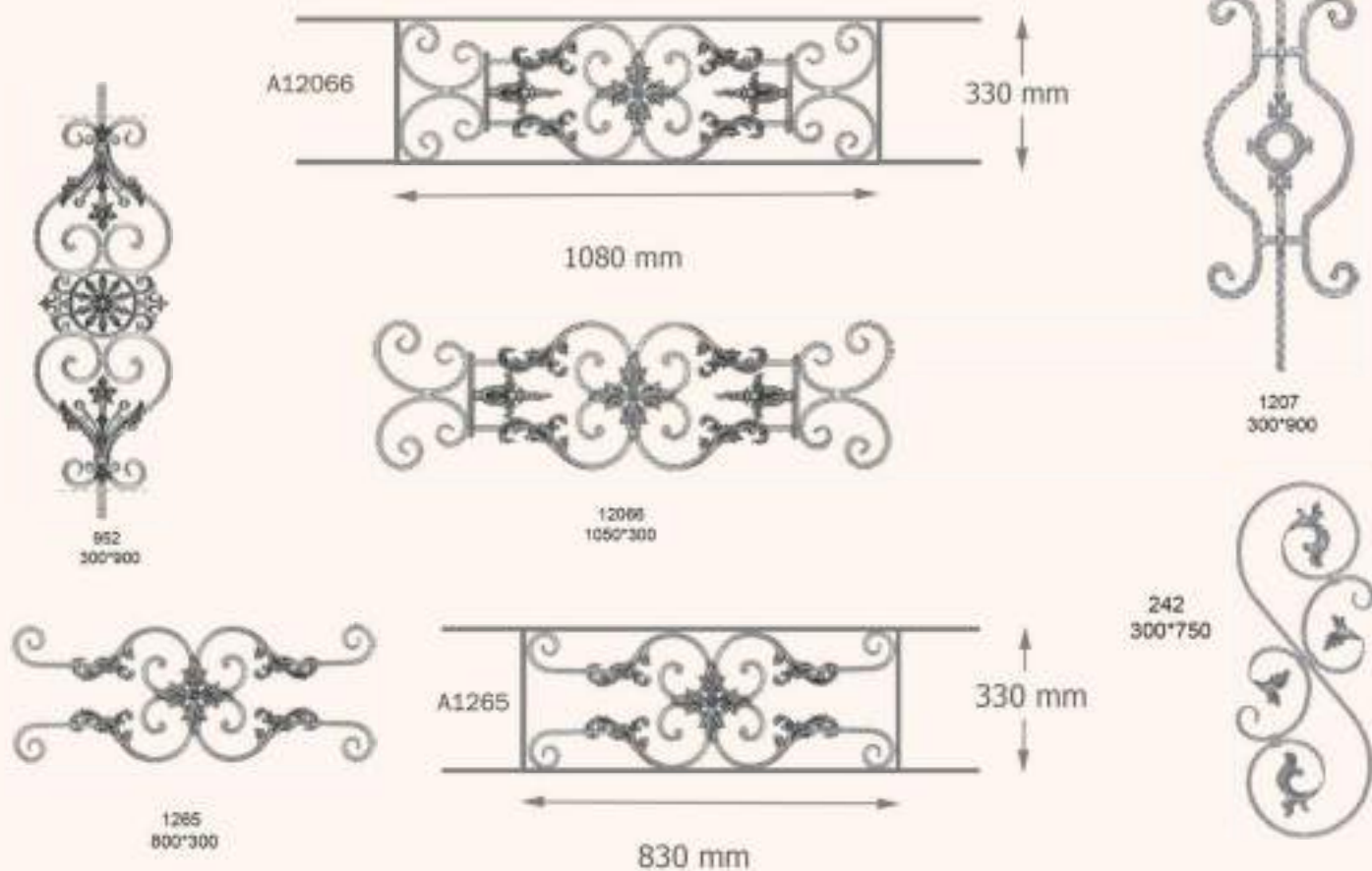

## BARREAU D'ESCALIER FONTE

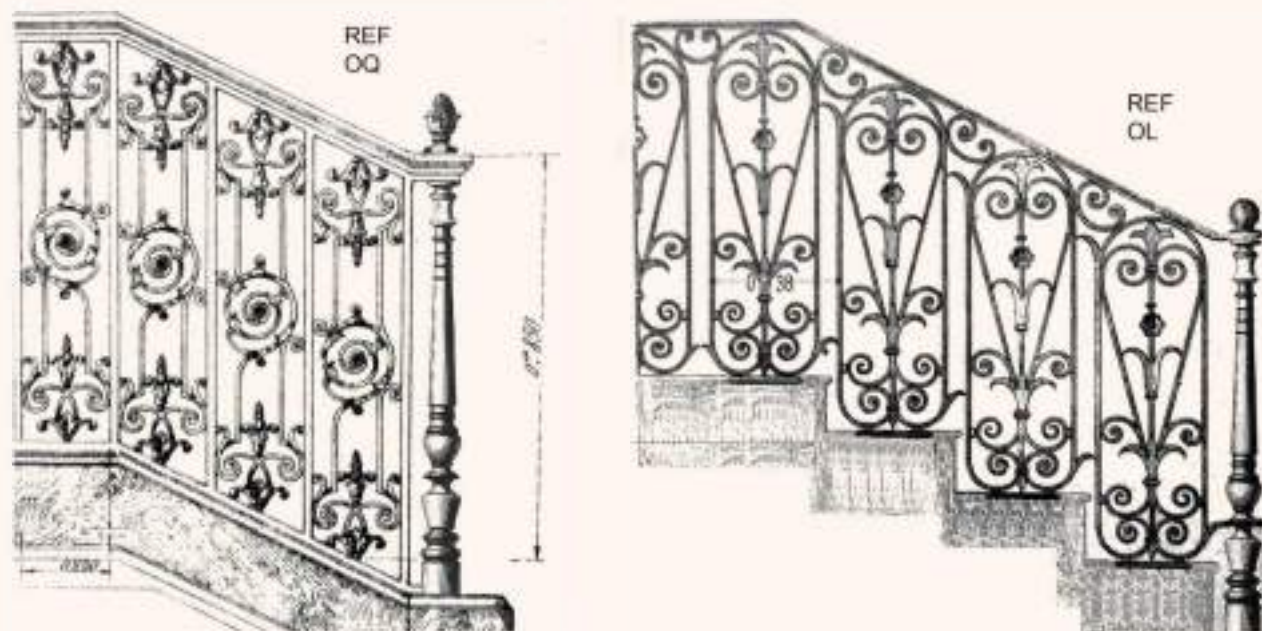

# LOISELET

Depuis 1850 à Nogent Le Roi Eure et Loir  
César Loiselet Créateur de l'industrie et de la fonte d'Art  
FONDERIE D'ART FONDERIE DE FONTE ET METALLIER

Eure et Loir Nogent Le Roi

65 rue du faubourg valmorin

## PILASTRE D'ESCALIER BARREAUX D'ESCALIER

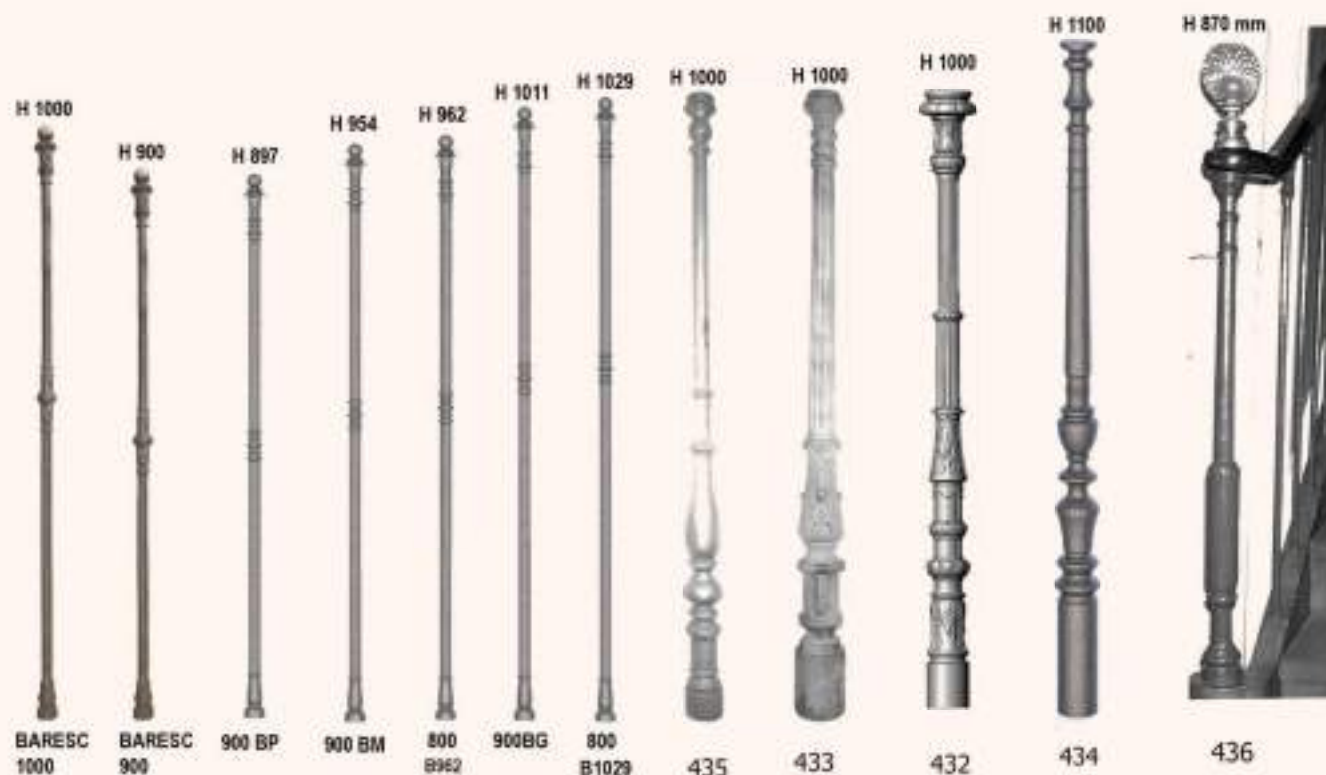

## PONTET BOULE FONTE FER FORGE POMME DE PIN



# LOISELET

Depuis 1850 à Nogent Le Roi Eure et Loir  
César Loiselet Créateur de l'industrie et de la fonte d'Art  
FONDERIE D'ART FONDERIE DE FONTE ET METALLIER

Eure et Loir Nogent Le Roi

65 rue du faubourg valmorin

## ESCALIER TYPE 800

DIAMETRE EXT 1600 mm  
PASSAGE 675 mm  
HAUTEUR DE MARCHE 200mm  
1 TOUR 14 MARCHES  
MONTE DROITE OU GAUCHE



Passage inférieur à 110mm conforme  
à la norme NFP 01 012 ( empêchant le  
passage d'une tête d'enfant)



# LOISELET

Depuis 1850 à Nogent Le Roi Eure et Loir  
César Loiselet Créateur de l'industrie et de la fonte d'Art  
FONDERIE D'ART FONDERIE DE FONTE ET METALLIER

Eure et Loir Nogent Le Roi

65 rue du faubourg valmorin

## ESCALIER

### TYPE 600

DIAMETRE EXT 1350 mm  
PASSAGE 550 mm  
HAUTEUR DE MARCHÉ 200mm  
1 TOUR 12MARCHES  
MONTE DROITE OU GAUCHE

Marche pleine ou ajourée



LOISELET



Fonte conforme à la norme NF P 01 013  
norme obligatoire pour tout garde-corps  
fonte résistante aux chocs



MARCHE PALIERE



EQUERRE 600  
CONTRE MARCHÉ 600  
MARCHÉ 600  
BOULON 600



Marche Ajourée



Marche pleine  
CONTRE MARCHÉ 600  
MARCHÉ 600  
BOULON 600

PLANCHE 60 COLLECTION LOISELET propriété de LOISELET reproduction interdite

COLLECTION REALISEE PAR Md Raymonde, Maud, M César, Henri, Albert, Jean, Yvon, François, Denis, Sylvain, Sébastien et Camille LOISELET

# LOISELET

Depuis 1850 à Nogent Le Roi Eure et Loir  
César Loiselet Créateur de l'industrie et de la fonte d'Art  
FONDERIE D'ART FONDERIE DE FONTE ET METALLIER

Eure et Loir Nogent Le Roi

65 rue du faubourg valmorin

## ESCALIER TYPE 970

DIAMETRE EXT 2000 mm  
PASSAGE 900 mm  
HAUTEUR DE MARCHE 170mm  
1 TOUR 16 MARCHES  
MONTÉ DROITE OU GAUCHE



# LOISELET

Depuis 1850 à Nogent Le Roi Eure et Loir  
César Loiselet Créateur de l'industrie et de la fonte d'Art  
FONDERIE D'ART FONDERIE DE FONTE ET METALLIER

Eure et Loir Nogent Le Roi

65 rue du faubourg valmorin

## KIOSQUE A MUSIQUE

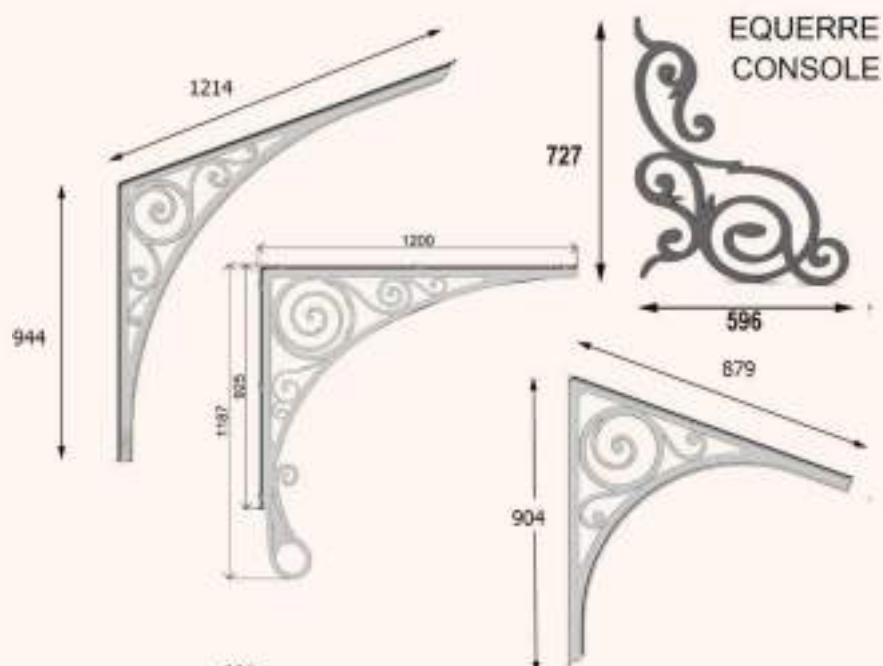

## EQUERRE CONSOLE

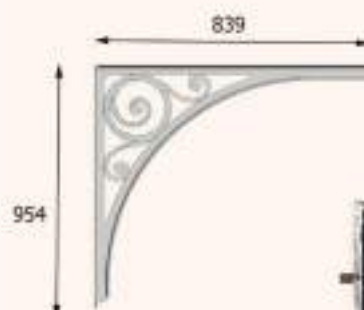

## LAMBREQUIN



## GRILLE DE SEPARATION

994 \* 363 mm



Fonte réf 270

1225\*685 mm + scellement 150 mm

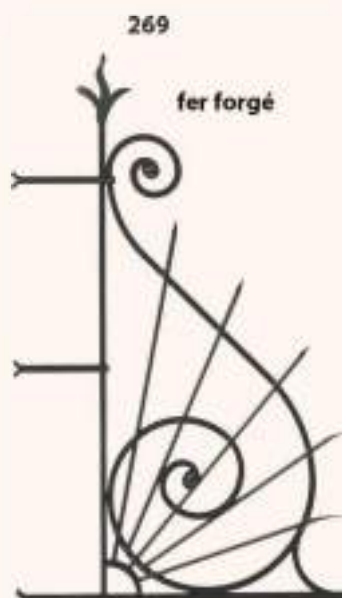

269

fer forgé

1240\*580

dimensions à la demande

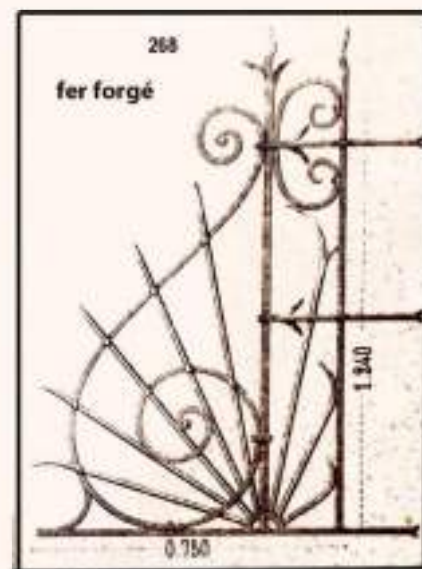

268

fer forgé

1.940

0.750

# LOISELET

Depuis 1850 à Nogent Le Roi Eure et Loir  
César Loiselet Créateur de l'industrie et de la fonte d'Art  
FONDERIE D'ART FONDERIE DE FONTE ET METALLIER

Eure et Loir Nogent Le Roi

65 rue du faubourg valmorin

## ESCALIER

Fabrication sur mesure



EGV



ESH



EFR



EGT



EBZ



ELD



ESX



EDJ

**PANNEAUX DE PORTE**



grille en fer forgé  
dimensions à la demande

QW



grille en fer forgé  
dimensions à la demande



QF

grille en fer forgé  
dimensions à la demande



QY

grille en fer forgé  
dimensions à la demande

QH



490

QX

grille en fer forgé  
dimensions à la demande



1080



ZI

1257 mm



664

QZ 240 mm

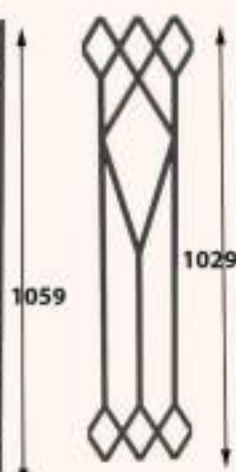

1059

1029

grille de porte  
dimensions à la demande

**FONTE**

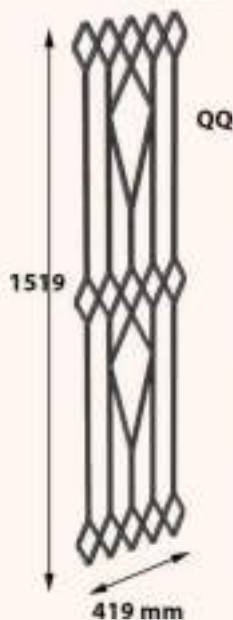

**FONTE**

QQ

1519

419 mm

dimensions à la demande

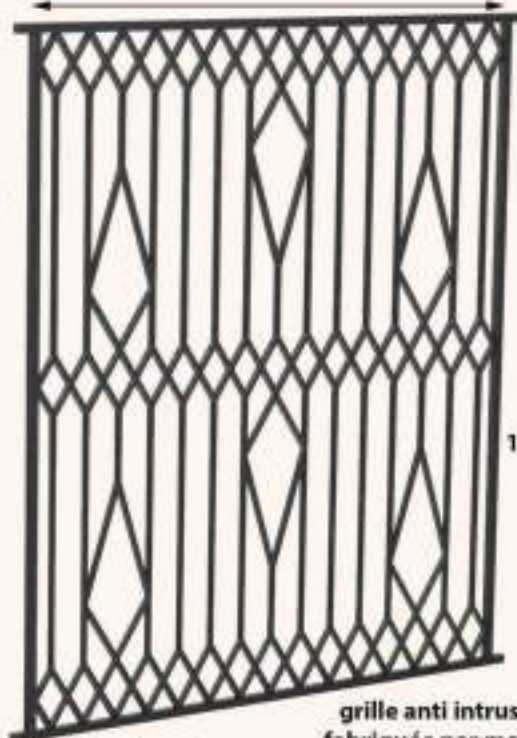

1559 mm

grille anti intrusion  
fabriquée par module  
de 419\*1519



# LOISELET

Depuis 1850 à Nogent Le Roi Eure et Loir  
César Loiselet Créateur de l'industrie et de la fonte d'Art  
FONDERIE D'ART FONDERIE DE FONTE ET METALLIER

Eure et Loir Nogent Le Roi

65 rue du faubourg valmorin

## PANNEAUX DE PORTE

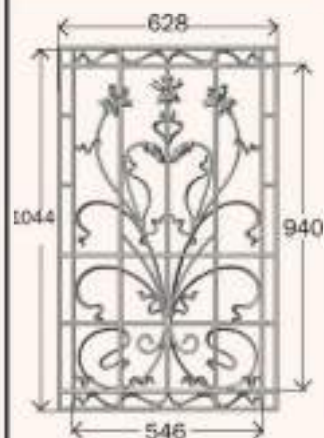

QD



MY  
1110\*530



JP  
1110\*590

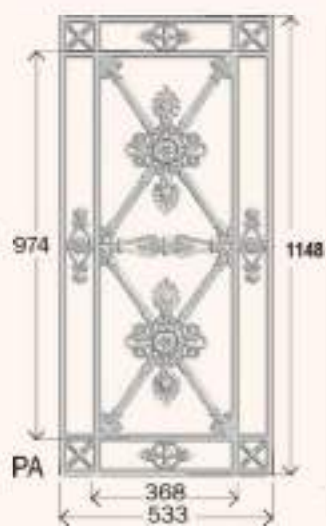

PA



QE  
1120X665



OL

HT1 1200 mm HT2 1100 mm  
LGI 460 mm

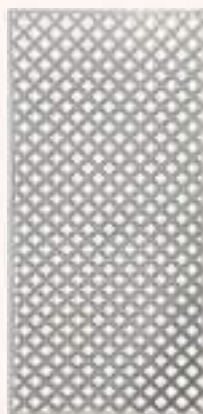

QA

355\*860 sans cadre  
maxi avec cadre 860\*895

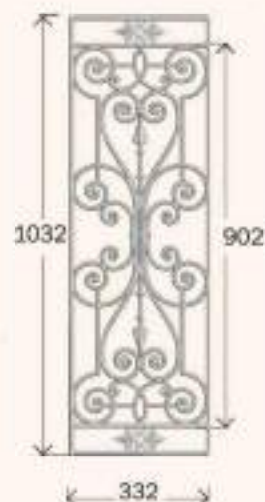

UT

# LOISELET

Depuis 1850 à Nogent Le Roi Eure et Loir  
César Loiselet Créateur de l'industrie et de la fonte d'Art  
FONDERIE D'ART FONDERIE DE FONTE ET METALLIER

Eure et Loir Nogent Le Roi

65 rue du faubourg valmorin

## PANNEAUX DE PORTE



1600 \* 740 mm  
KF



1600 \* 307 mm  
KG

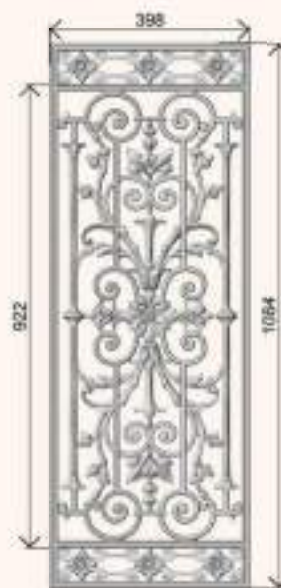

KH



1015\*590 mm  
MG



MO  
895\*405

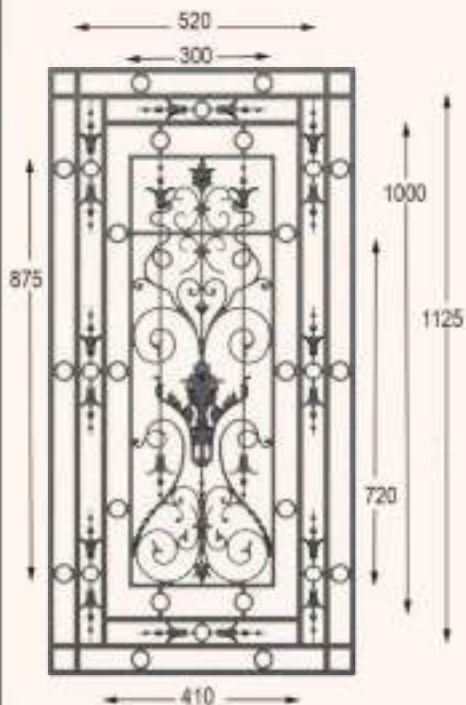

QB  
1230\*620mm



1125\*615 mm  
QP



RC

# LOISELET

Depuis 1850 à Nogent Le Roi Eure et Loir  
César Loiselet Créateur de l'industrie et de la fonte d'Art  
FONDERIE D'ART FONDERIE DE FONTE ET METALLIER

Eure et Loir Nogent Le Roi

65 rue du faubourg valmorin

## COLONNE FONTE ET FER

L'entreprise Loiselet conçoit et fabrique des colonnes modulaires, en fonte, en aluminium et en fer, elles sont décoratives, architecturales et des poteaux ou piliers sur mesures, moulés au sable 'à vert'. Initialement conçues pour l'extérieur (vérandas, pergolas, auvents, préaux, marquises...), ces colonnes décoratives et structurales inspirées de modèles anciens s'emploient aussi pour la décoration ou la rénovation d'intérieurs (lofts, restaurants, brasseries, pubs, boutiques...). Ces colonnes et poteaux peuvent servir de descentes de gouttières, ainsi que d'éléments de structure tels que la colonne en fonte cannelée ou des chapiteaux ornés.



platine pour fixation de la colonne  
au sol ou au plafond à la demande

ref 20 coulée en 2 parties  
hauteur maxi 3000 mm, mini 2445 mm

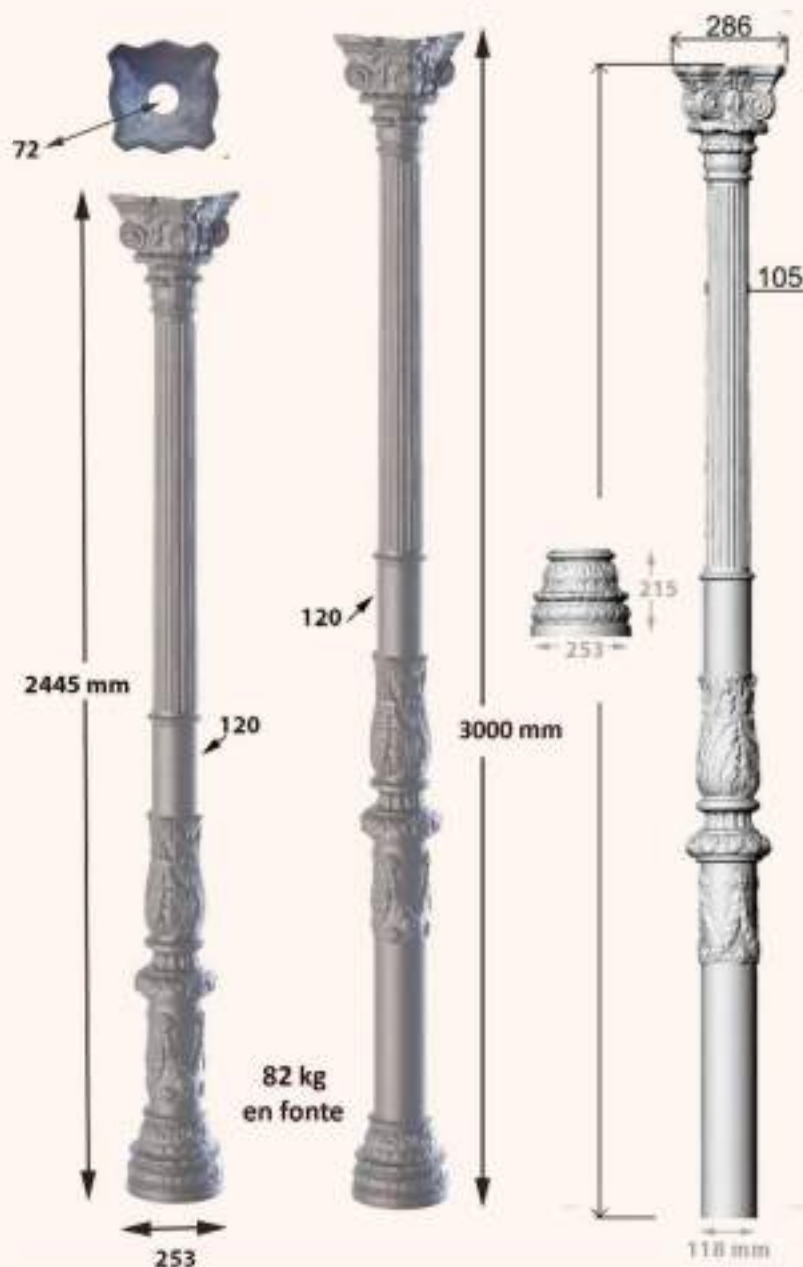

ref 14 coulée en 2 parties,  
tube central en fer creux ou plein  
hauteur à la demande

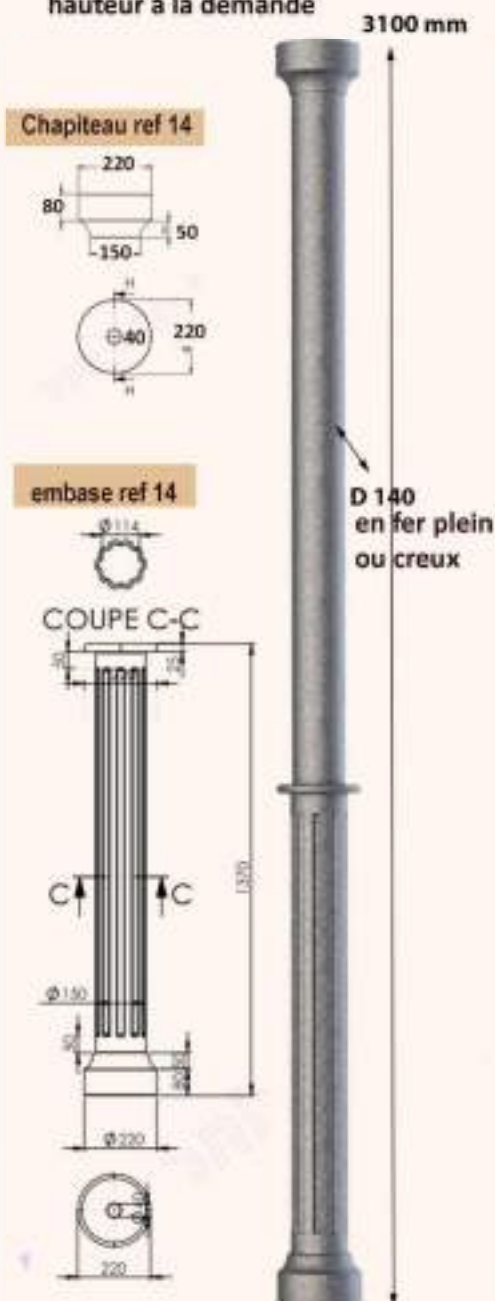

COLONNE FONTE ET FER



platine pour fixation de la colonne  
au sol ou au plafond à la demande

ref 12 coulée en 2 parties,  
tube central en fer creux ou plein  
hauteur à la demande

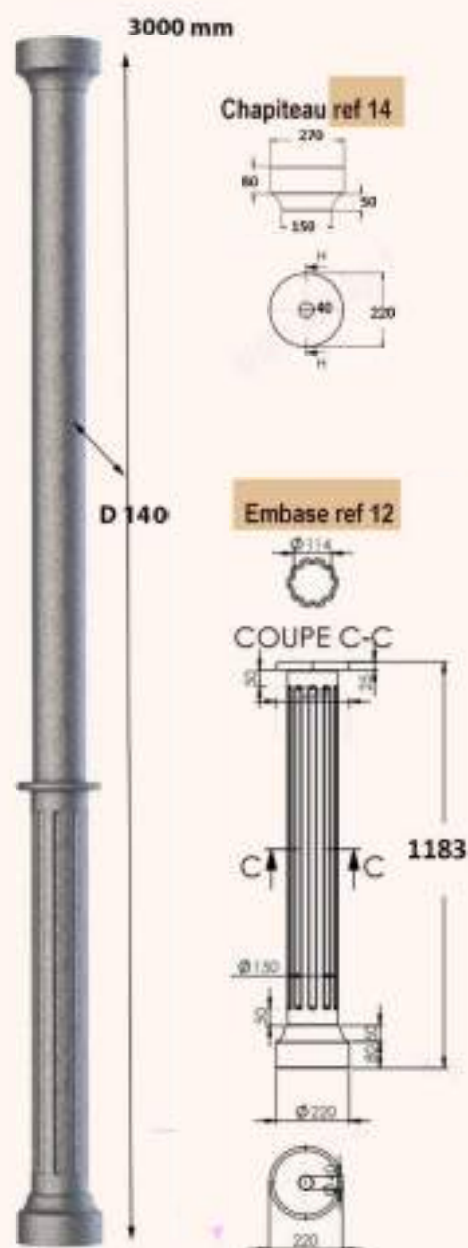

ref 5 coulée en 2 ou 3 pièces  
tube en fer creux ou plein



ref 5 Chapiteau

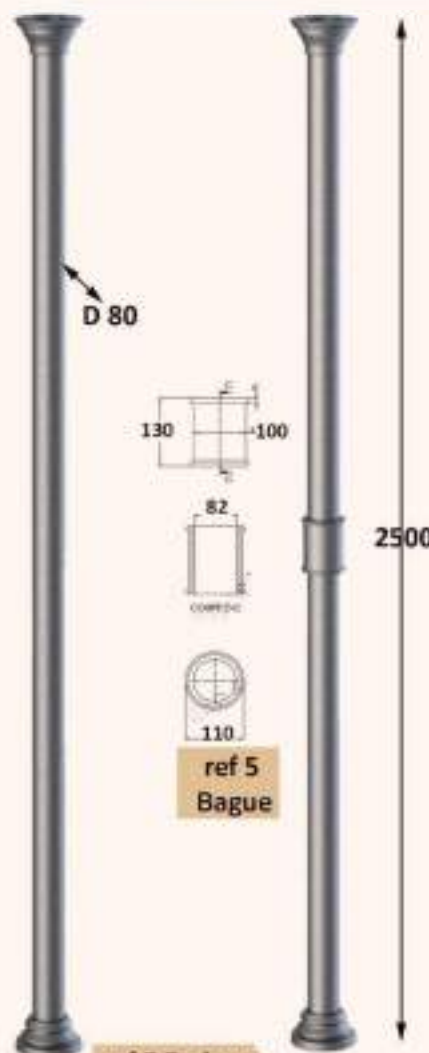

ref 5 Embase

ref 3 coulée en 2 pièces  
tube en fer creux ou plein



ref 3 chapiteau

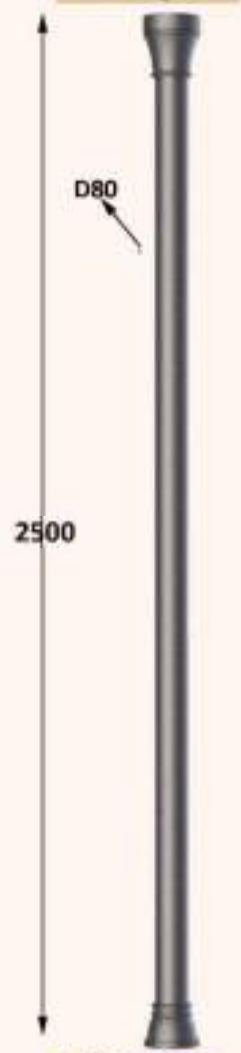

ref 3 embase



COLONNE FONTE ET FER



platine pour fixation de la colonne  
au sol ou au plafond à la demande



chapiteau ref 30 en fonte ou aluminium



Chapiteau  
colonne ref 11

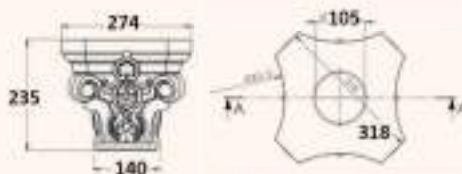

tube D100  
en fer plein  
ou creux

tube D100  
en fer plein  
ou creux

Ref 43  
Fonte

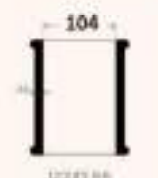

bague ref 30  
en fonte ou  
aluminium



exemple de  
fixation de  
la colonne

embase ref 30  
en fonte  
ou aluminium

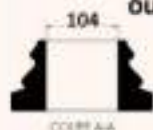

2220

380

# LOISELET

Depuis 1850 à Nogent Le Roi Eure et Loir  
César Loiselet Créateur de l'industrie et de la fonte d'Art  
FONDERIE D'ART FONDERIE DE FONTE ET METALLIER

Eure et Loir Nogent Le Roi

65 rue du faubourg valmorin

## COLONNE FONTE ET FER



platine pour fixation de la colonne  
au sol ou au plafond à la demande

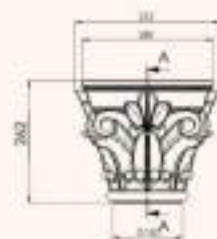

CHAPITEAU REF 41  
FONTE



FUT  
réf 42



VUE DE DESSUS  
CHAPITEAU réf 42



EMBASE ref 42

Hauteur modifiable (maxi 3000 mm)



Hauteur non modifiable

FUT 33

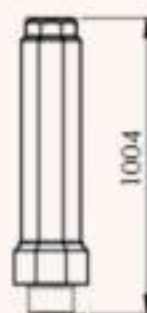

embase ref 6

# LOISELET

Depuis 1850 à Nogent Le Roi Eure et Loir  
César Loiselet Créateur de l'industrie et de la fonte d'Art  
FONDERIE D'ART FONDERIE DE FONTE ET METALLIER

Eure et Loir Nogent Le Roi

65 rue du faubourg valmorin

## COLONNE FONTE ET FER



platine pour fixation de la colonne  
au sol ou au plafond à la demande



colonne pour serre  
de jardin ref 23



2003 mm

HAUTEUR A LA DEMANDE

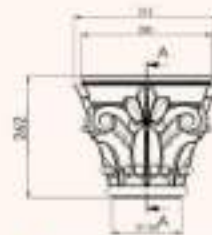

CHAPITEAU REF 41  
FONTE

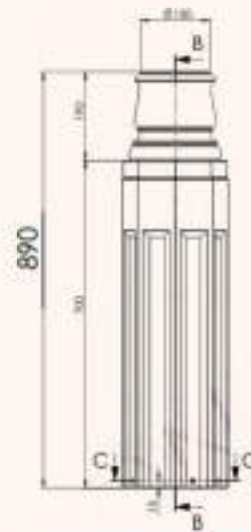

EMBASE FONTE REF 41  
FONTE



TUBE ACIER



FONTE

FONTE

# LOISELET

Depuis 1850 à Nogent Le Roi Eure et Loir  
César Loiselet Créateur de l'industrie et de la fonte d'Art  
FONDERIE D'ART FONDERIE DE FONTE ET METALLIER

Eure et Loir Nogent Le Roi

65 rue du faubourg valmorin

## COLONNE FONTE ET FER



platine pour fixation de la colonne  
au sol ou au plafond à la demande



2900 mm

hauteur adaptable maxi 2900 mm  
nouveau : fonte soudable

chapiteau fonte  
ref 8

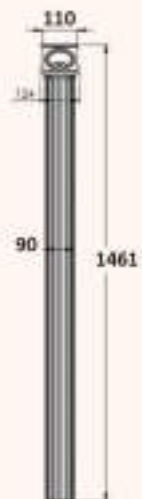
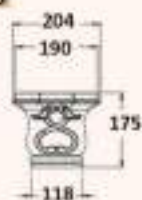

fut bas  
ref 8

fut haut  
ref 8

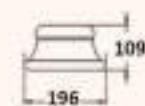

Embase fonte ref 8



demi chapiteau ref 24

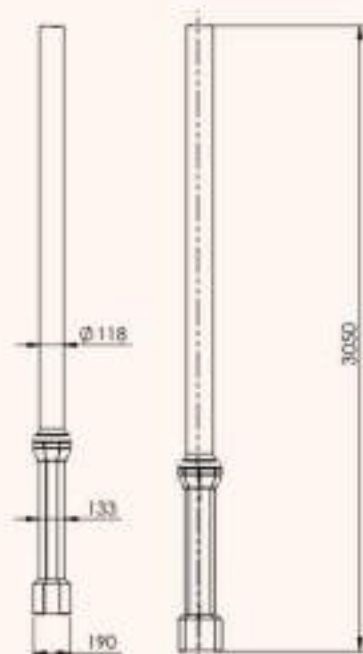

fut en fonte ou aluminium  
ref 24





COLONNE FONTE ET FER

ref 9 : 100% fonte ou aluminium

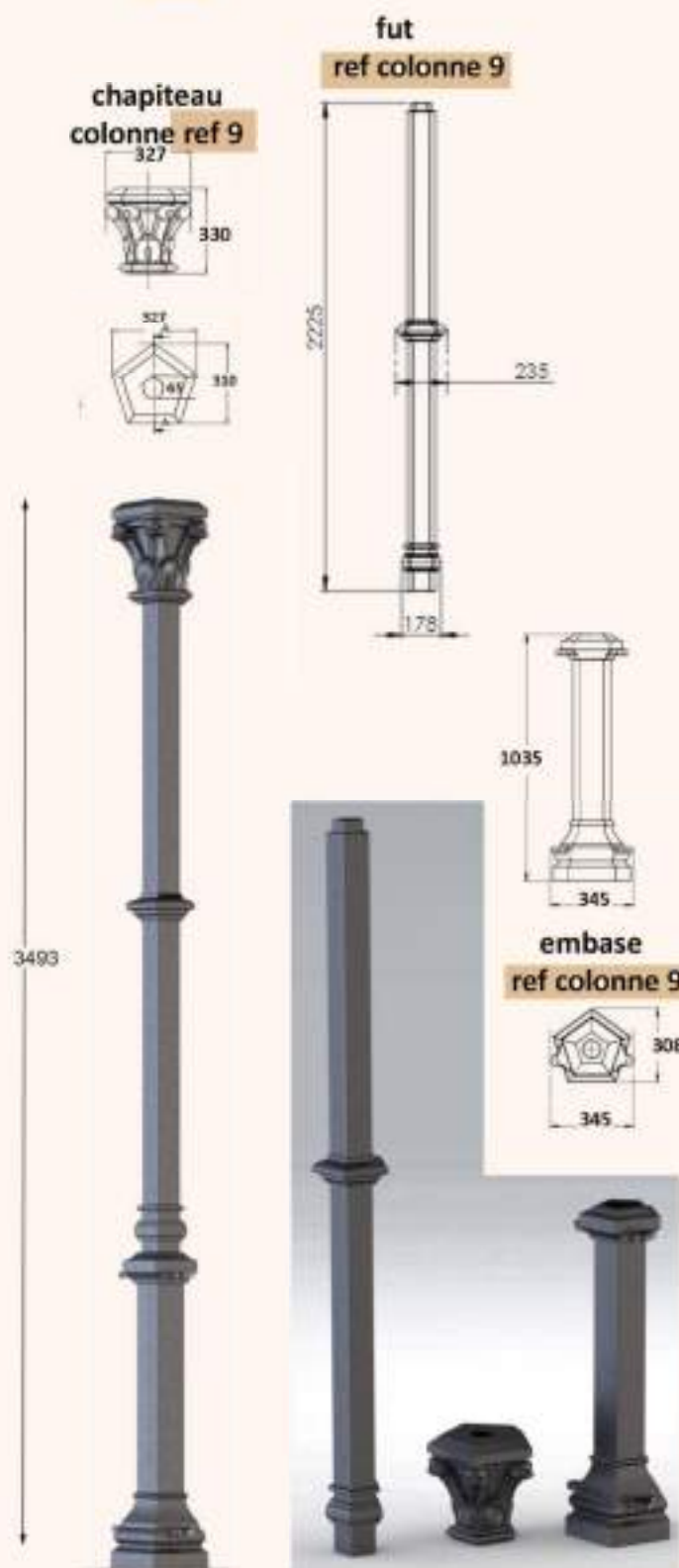

ref 7 : fonte ou aluminium et tube en fer  
hauteur à la demande

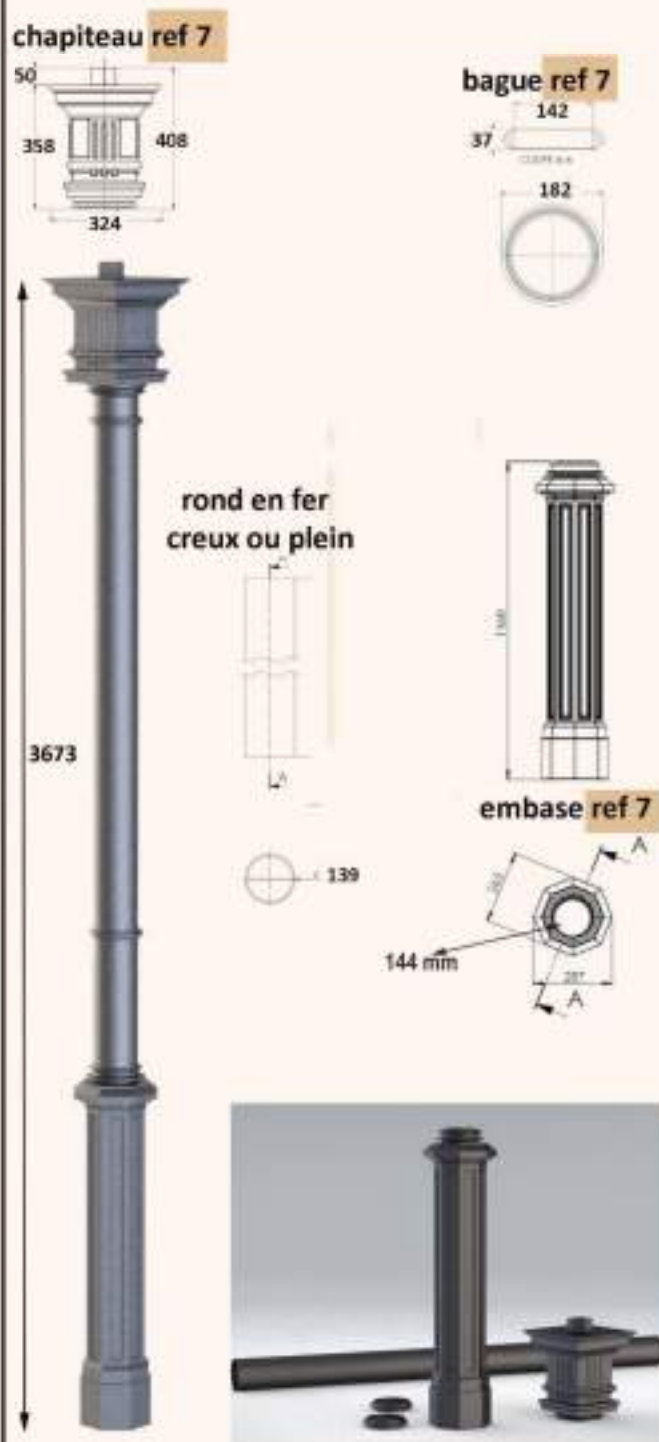

# LOISELET

Depuis 1850 à Nogent Le Roi Eure et Loir  
César Loiselet Créateur de l'industrie et de la fonte d'Art  
FONDERIE D'ART FONDERIE DE FONTE ET METALLIER

Eure et Loir Nogent Le Roi

65 rue du faubourg valmorin

## COLONNE FONTE ET FER



ref 6 et 21 : 100% fonte ou aluminium



chapiteau ref 6

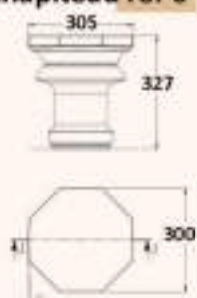

fut ref 6PM



bague ref 6

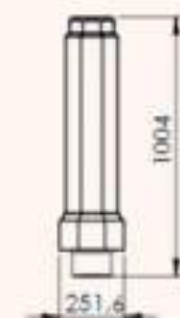

embase ref 6

fut ref 6GM



ref 21  
en fonte  
843 kg en plein  
également en creux

# LOISELET

Depuis 1850 à Nogent Le Roi Eure et Loir  
César Loiselet Créateur de l'industrie et de la fonte d'Art  
FONDERIE D'ART FONDERIE DE FONTE ET METALLIER

Eure et Loir Nogent Le Roi

65 rue du faubourg valmorin

## COLONNE FONTE ET FER



platine pour fixation de la colonne  
au sol ou au plafond à la demande

**ref 15**  
fonte et fer  
hauteur à la demande

5000 mm

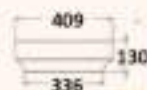

chapiteau ref 15



Ø 273  
fer plein  
ou creux



COUPE E-E

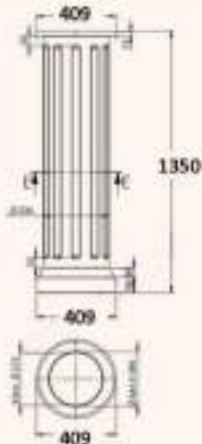

embase ref 15

**ref 10**  
100% fonte  
fonte résistante aux chocs



**ref 22**  
fonte et fer  
hauteur à la demande



fonte

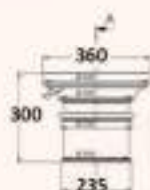

chapiteau  
ref 22

Ø 194  
fer plein  
ou creux



embase ref 22



fonte

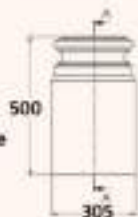



# LOISELET

Depuis 1850 à Nogent Le Roi Eure et Loir  
César Loiselet Créateur de l'industrie et de la fonte d'Art  
FONDERIE D'ART FONDERIE DE FONTE ET METALLIER

Eure et Loir Nogent Le Roi

65 rue du faubourg valmorin

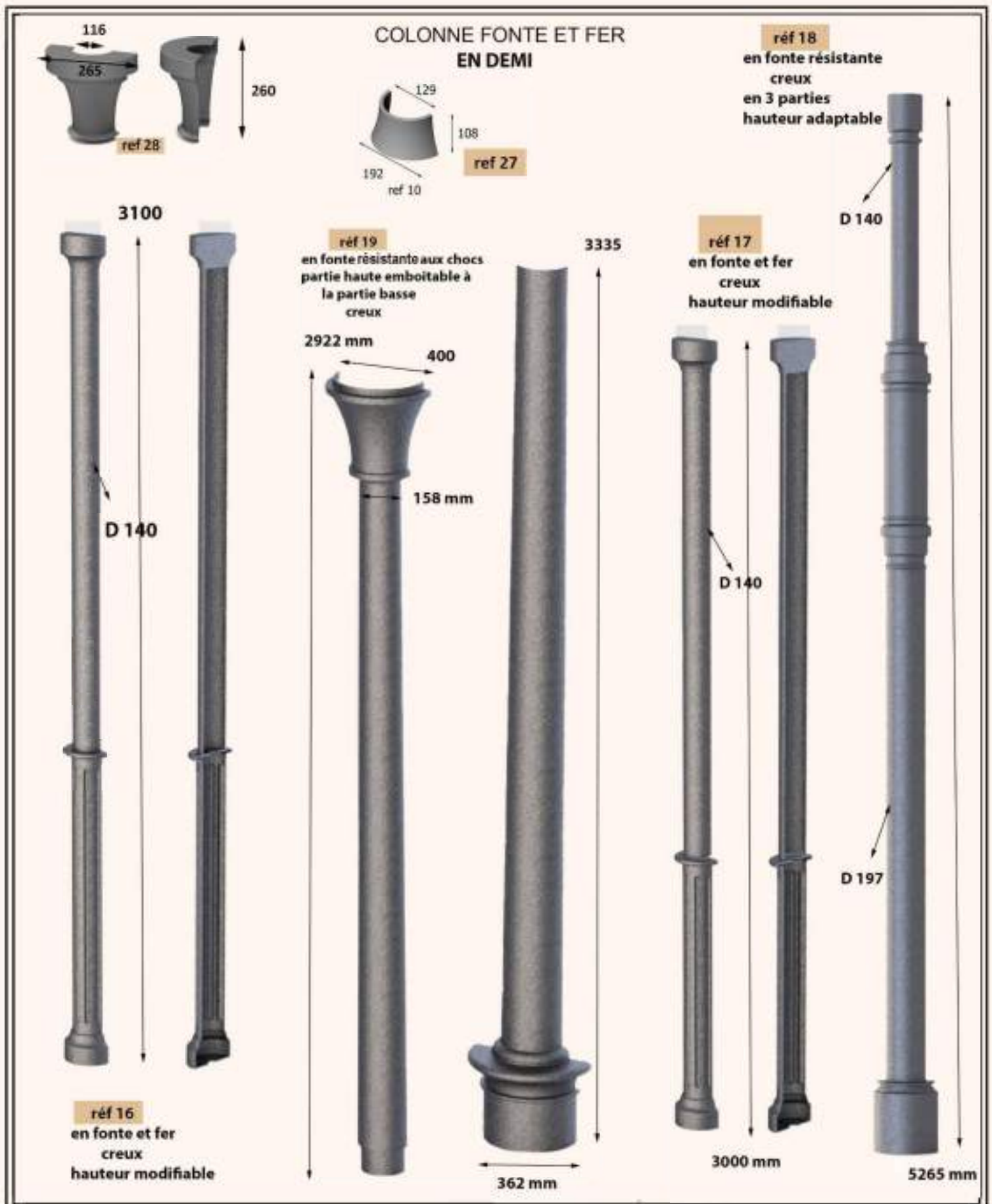

# LOISELET

Depuis 1850 à Nogent Le Roi Eure et Loir  
César Loiselet Créateur de l'industrie et de la fonte d'Art  
FONDERIE D'ART FONDERIE DE FONTE ET METALLIER

Eure et Loir Nogent Le Roi

65 rue du faubourg valmorin



PLANCHE 78 COLLECTION LOISELET propriété de LOISELET reproduction interdite

COLLECTION REALISEE PAR M<sup>l</sup> Raymonde, Maul, M César, Henri, Albert, Jean, Yvon, François, Denis, Sylvain, Sébastien et Camille LOISELET

# LOISELET

Depuis 1850 à Nogent Le Roi Eure et Loir  
César Loiselet Créateur de l'industrie et de la fonte d'Art  
FONDERIE D'ART FONDERIE DE FONTE ET METALLIER

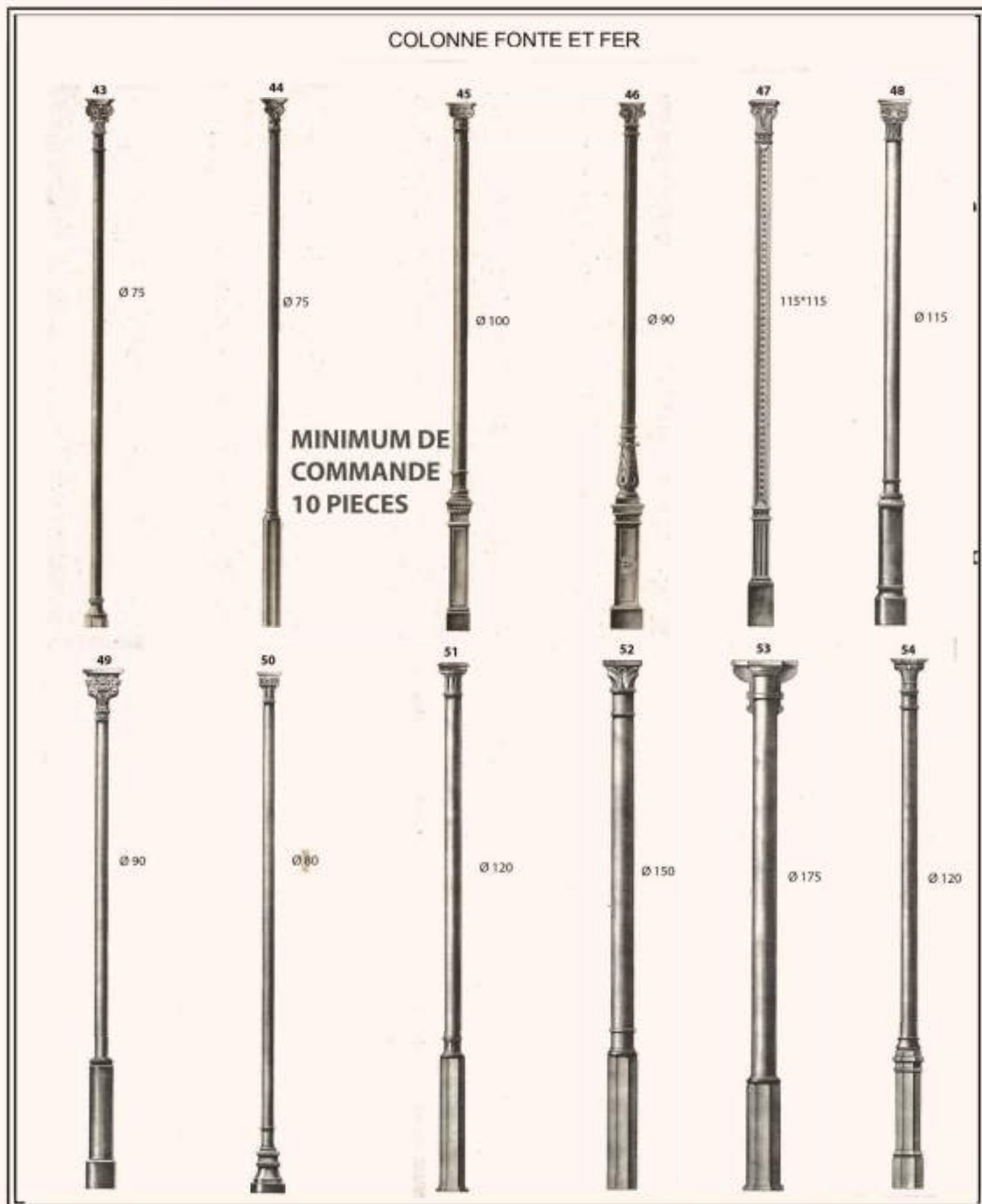
Eure et Loir Nogent Le Roi

65 rue du faubourg valmorin

## COLONNE FONTE ET FER

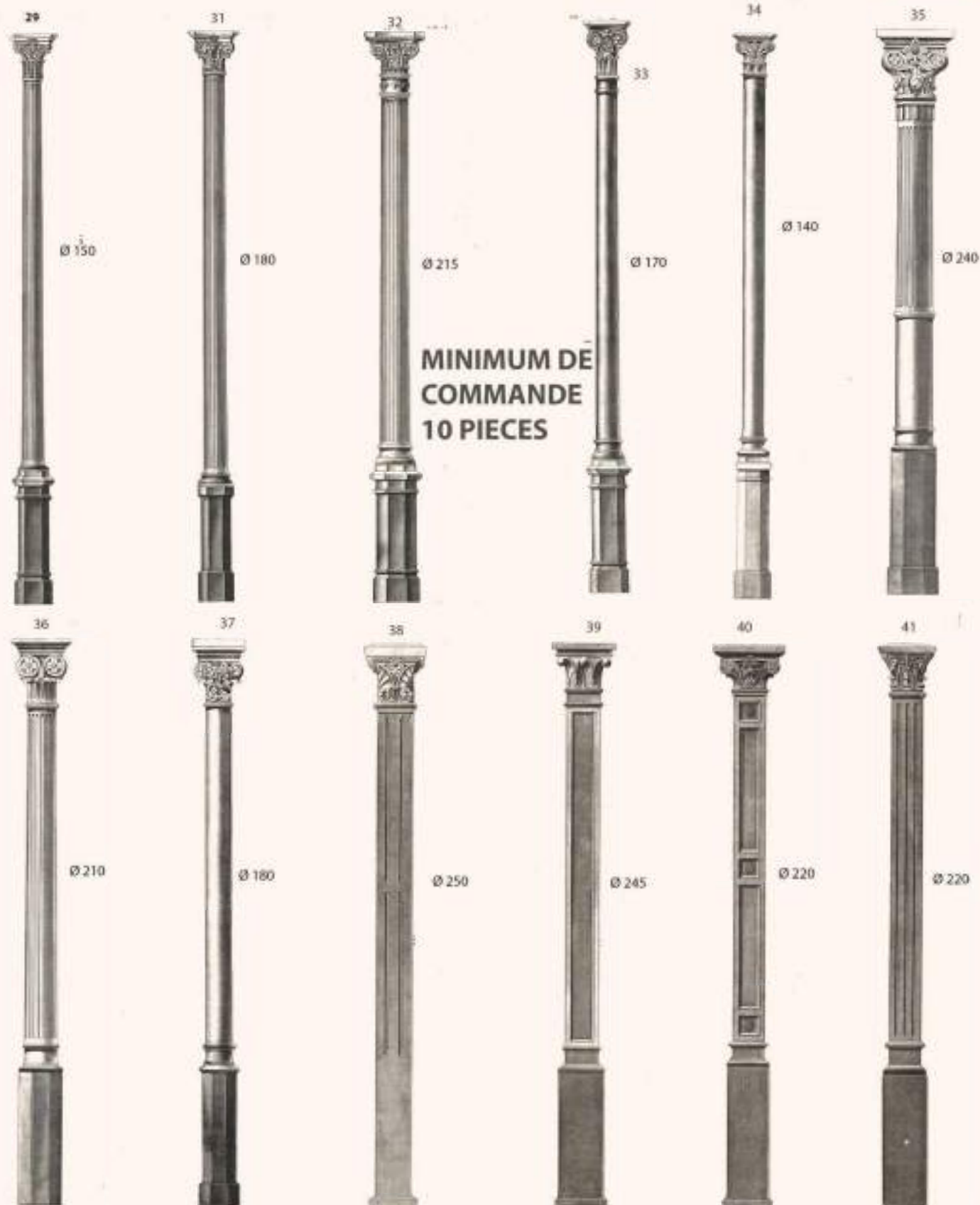

# LOISELET

Depuis 1850 à Nogent Le Roi Eure et Loir  
César Loiselet Créateur de l'industrie et de la fonte d'Art  
FONDERIE D'ART FONDERIE DE FONTE ET METALLIER

Eure et Loir Nogent Le Roi

65 rue du faubourg valmorin

## GRILLE DE VENTILATION , D'AERATION , GRILLE DE CHAUFFAGE

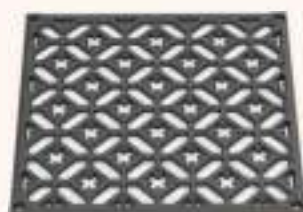

200\*200  
150\*150



180 mm  
130  
160



240\*120 mm  
• 210 x 120  
• 220 x 60  
• 220 x 110



220\*60



55 mm



110 mm



180\*120 mm  
• 110 x 60  
• 110 x 100  
• 130 x 100  
• 160 x 100

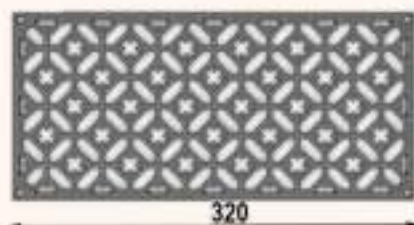

320

150

5



160\*125



500\*150



220\*160



110\*70



132\*145



Grille réglable  
175\*120



210\*70



Grille réglable  
200\*110



Grille réglable  
175\*75



# LOISELET

Depuis 1850 à Nogent Le Roi Eure et Loir  
César Loiselet Créateur de l'industrie et de la fonte d'Art  
FONDERIE D'ART FONDERIE DE FONTE ET METALLIER

Eure et Loir Nogent Le Roi

65 rue du faubourg valmorin

## GRILLE DE VENTILATION , D'AERATION , GRILLE DE CHAUFFAGE

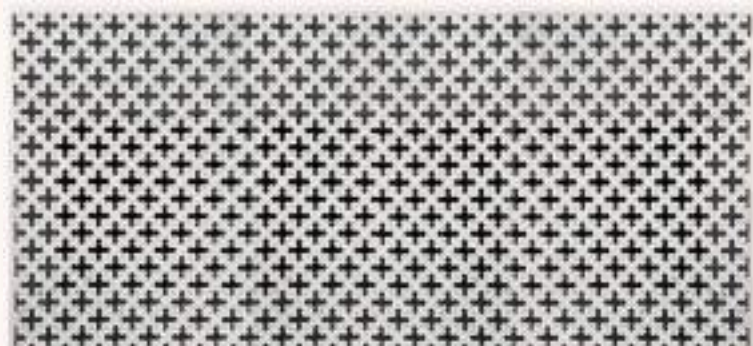

QV  
1370\*672 mm



QR  
470\*470



QU  
490\*490

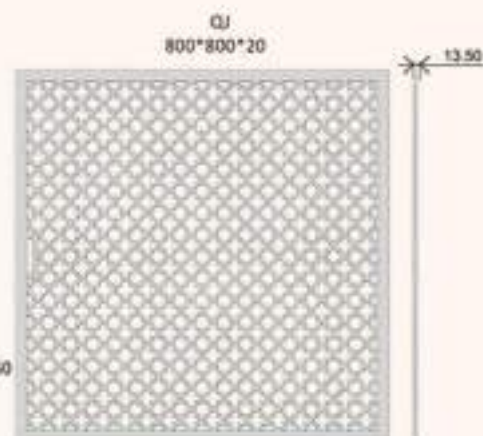

QL  
500\*750

QJ  
800\*800\*20

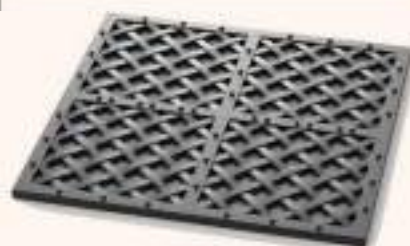

KB  
682\*682\*20

KC  
1187\*203\*14

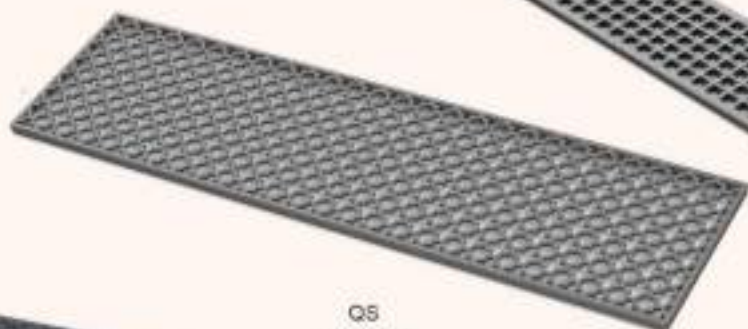
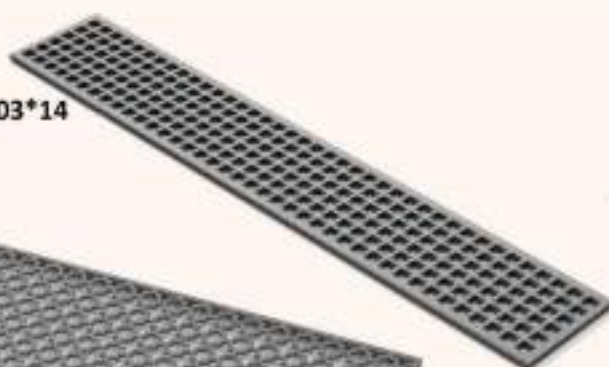

QS  
1200\*335

KI  
500\*750

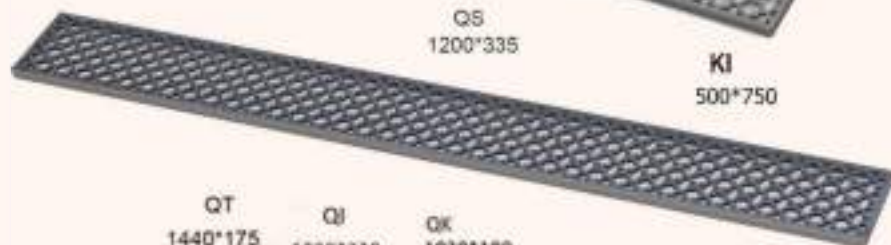

QT  
1440\*175

QI  
1020\*220

QK  
1020\*180



QA  
355\*860 sans cadre  
maxi avec cadre 660\*695

# LOISELET

Depuis 1850 à Nogent Le Roi Eure et Loir  
César Loiselet Créateur de l'industrie et de la fonte d'Art  
FONDERIE D'ART FONDERIE DE FONTE ET METALLIER

Eure et Loir Nogent Le Roi

65 rue du faubourg valmorin

## GRILLE GRATTE PIEDS , DECROTOIR



QR  
470\*470

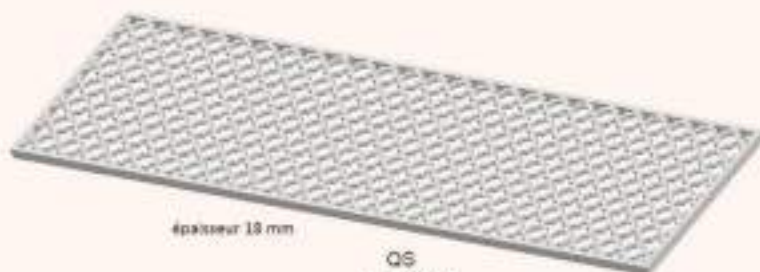

épaisseur 18 mm

QS  
1200\*335



600\*300

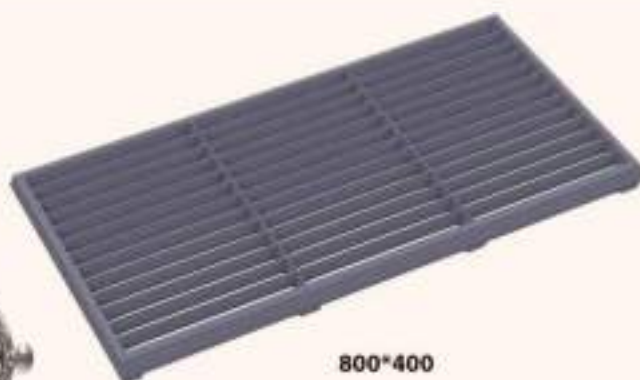

800\*400



374h \* 238 l

QM



Tire-botte en fonte



1040\*454\*224



690\*345\*10

QN

QO

# LOISELET

Depuis 1850 à Nogent Le Roi Eure et Loir  
César Loiselet Créateur de l'industrie et de la fonte d'Art  
FONDERIE D'ART FONDERIE DE FONTE ET METALLIER

Eure et Loir Nogent Le Roi

65 rue du faubourg valmorin

## BACS ET CAISSES A ORANGER FONTE ET CHENE

DIMENSIONS EN MM DES DIFFERENTS MODELES DE BAC

	Capacité (litres)						
	XS 200	M 500	L 700	L 800	XL 900	XL 1075	XXL 1200
A	320	500	690	850	1000	1180	1320
B	200	500	700	800	900	1075	1200



L 800

AUTRES DIMENSIONS NOUS CONSULTER



XL 900



XL 1075



XS 200



**ROSACE FONTE POUR ESCALIER PORTAIL**



**1390 / ROSACE**  
Ø : 60 mm  
Poids : 0,170 Kg



**1440 / ROSACE**  
Ø : 80 mm  
Ø : 90 Ø : 130  
Ø : 105 mm



**1560 / ROSACE**  
Ø : 52 mm  
Ø : 16 mm  
Poids : 0,050 Kg



1538  
39 mm



124  
70\*70 mm



1630  
72 mm  
FLEUR D'EAU



667  
210\*210



1660  
58 mm  
liquidambar



384  
270\*270



1552  
Ø 55



Nénuphar  
1551  
D46



1550  
D70  
Coupelle



1650  
71\*71 h 13mm  
CROCUS



1640  
85\*85 h 17  
Lis



DOUBLE  
FLEUR



1710  
91\*91 h 20mm



62\*62  
1675



diamètre 70 mm  
1680



Ethnic  
diamètre 70 mm



diamètre 22 mm  
1690



1670  
diamètre 84 mm

**CACHE POTEAU BALUSTRADE**

394  
95\*95



395  
50\*50



561  
50\*50



324  
130\*130



639  
20\*40

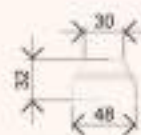

CS30



155  
110\*110



393  
120 mm



392  
160 mm

Ce plan est la propriété de la Société Loiselet et ne peut pas être modifié sans autorisation.

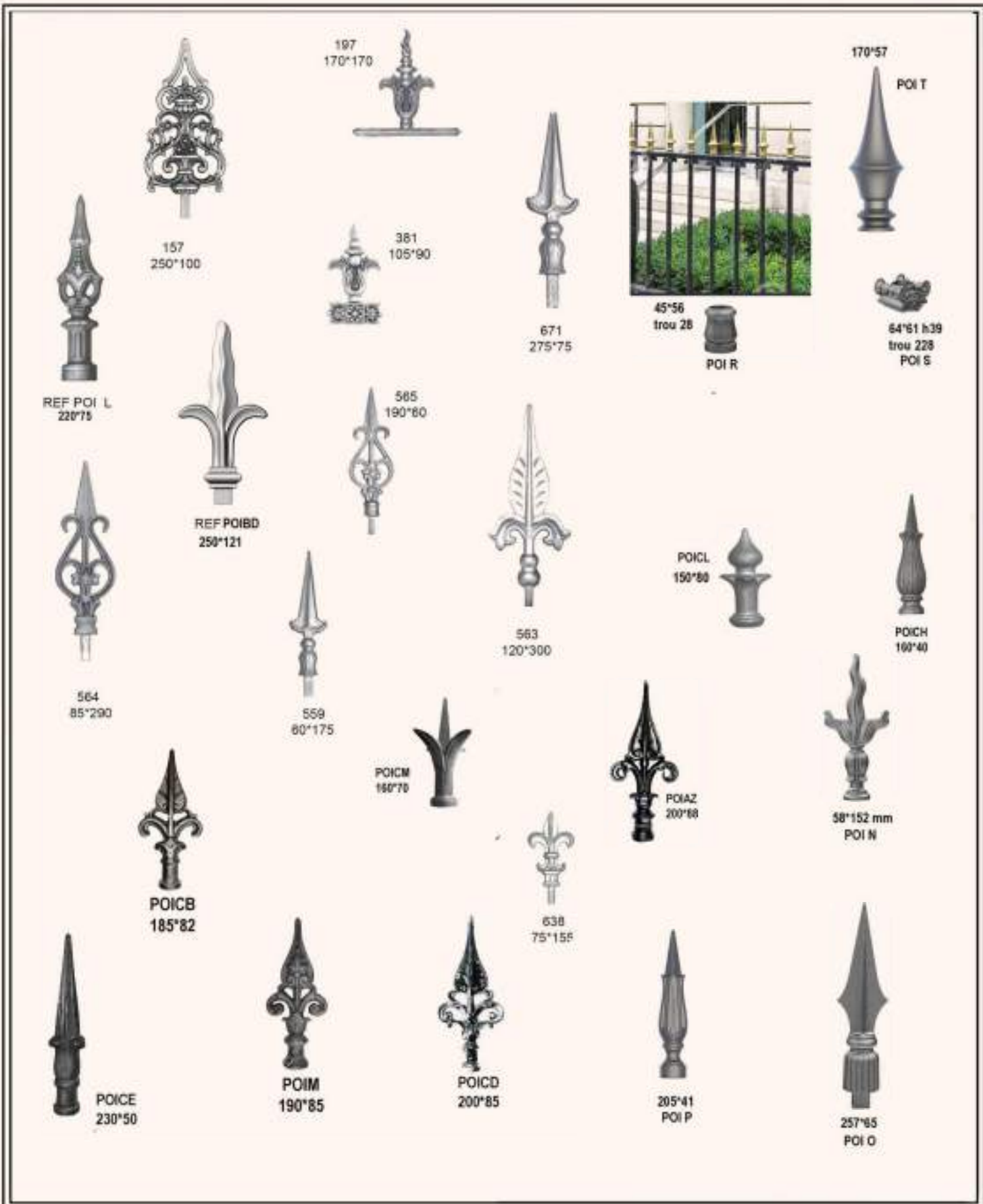

# LOISELET

Depuis 1850 à Nogent Le Roi Eure et Loir  
César Loiselet Créateur de l'industrie et de la fonte d'Art  
FONDERIE D'ART FONDERIE DE FONTE ET METALLIER

Eure et Loir Nogent Le Roi

## POINTES DE GRILLES

65 rue du faubourg valmorin



REF : POI J  
348\*90 mm



Ht : 225 mm  
Lg: 95 mm  
D: 40 mm  
REF: POI H



POICF  
240\*70



Ht : 145 mm  
Lg: 54 mm  
D: 25 mm  
REF: POI A



Ht : 153 mm  
Lg: 42 mm  
D: 23 mm  
REF: POI B



Ht : 195 mm  
Lg: 99 mm  
D: 35 mm  
REF: POI C



Ht: 280 mm  
Lg: 80 mm  
D: 45 mm



POIAA  
180\*104 mm



POIAB  
200\*43



Ht : 200 mm  
Lg: 75 mm  
D: 35 mm  
REF: POI D



Ht : 220 mm  
Lg: 50 mm  
D: 40 mm  
REF: POI E

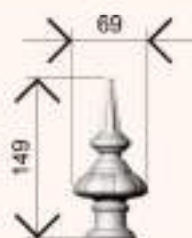

POICN



Ht : 220 mm  
Lg: 110 mm  
D: 35 mm  
REF: POI G



REF: POI F

Ht : 220 mm  
Lg: 110 mm  
D: 40 mm



POICP



POIW

Ht : 286  
Lg : 100  
D : 45



REF: POI I

Ht : 270 mm  
Lg: 80 mm  
D: 50 mm

# LOISELET

Depuis 1850 à Nogent Le Roi Eure et Loir  
César Loiselet Créateur de l'industrie et de la fonte d'Art  
FONDERIE D'ART FONDERIE DE FONTE ET METALLIER

Eure et Loir Nogent Le Roi

65 rue du faubourg valmorin

## VOLUTE EN FER FORGE POUR COMPOSER PORTAIL GARDE CORPS BALUSTRADE RAMPE D'ESCALIER



288  
200\*180



202  
260\*160



254  
120\*80



365  
300\*130 mm



287  
445\*330



293  
190\*310 mm



377  
300\*120 mm



284  
340\*250



366  
250\*120 mm



286  
385\*285

264  
355\*145 mm



266  
140\*70



A283



770 mm

283  
150\*210



180 mm

# LOISELET

Depuis 1850 à Nogent Le Roi Eure et Loir  
César Loiselet Créateur de l'industrie et de la fonte d'Art  
FONDERIE D'ART FONDERIE DE FONTE ET METALLIER

Eure et Loir Nogent Le Roi

65 rue du faubourg valmorin

## ELEMENT FER FORGE ET FONTE POUR DECORATION PORTAIL GARDE CORPS BALUSTRADE



960  
800\*300



A960

830 mm

320 mm

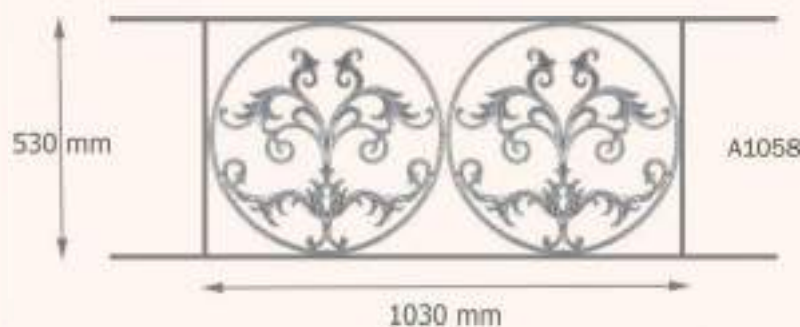

530 mm

A1058

1030 mm



1058  
500\*500



1054  
500\*500

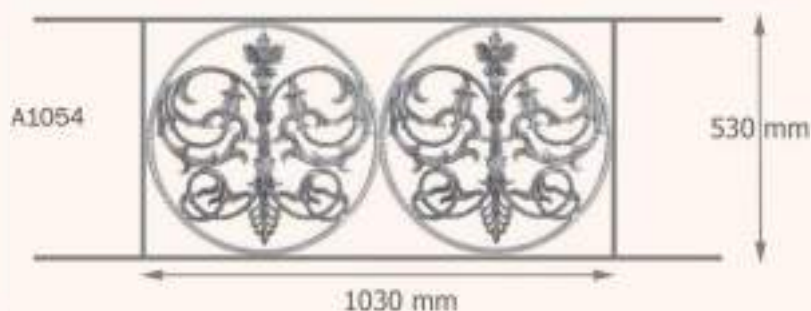

A1054

1030 mm

530 mm



1264  
800\*800



1263  
800\*800



# LOISELET

Depuis 1850 à Nogent Le Roi Eure et Loir  
César Loiselet Créateur de l'industrie et de la fonte d'Art  
FONDERIE D'ART FONDERIE DE FONTE ET METALLIER

Eure et Loir Nogent Le Roi

65 rue du faubourg valmorin

## ELEMENT FER FORGE ET FONTE POUR DECORATION PORTAIL GARDE CORPS BALUSTRADE



1288  
1250\*650



A1288

950 mm

1280 mm



A1280

480 mm

800 mm



1280  
800\*450

1030 mm



1322  
870\*400



430 mm

A1322

870 mm

1040 mm



A1290

440 mm

880 mm



1290  
880\*410

# LOISELET

Depuis 1850 à Nogent Le Roi Eure et Loir  
César Loiselet Créateur de l'industrie et de la fonte d'Art  
FONDERIE D'ART FONDERIE DE FONTE ET METALLIER

Eure et Loir Nogent Le Roi

65 rue du faubourg valmorin

## MARQUISES

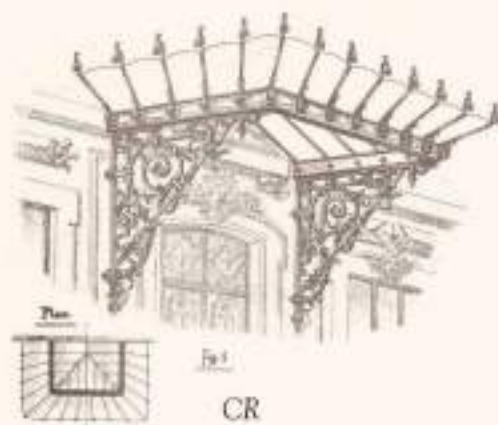
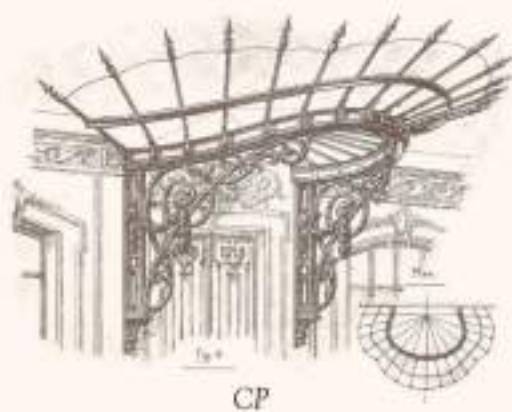

# LOISELET

Depuis 1850 à Nogent Le Roi Eure et Loir  
César Loiselet Créateur de l'industrie et de la fonte d'Art  
FONDERIE D'ART FONDERIE DE FONTE ET METALLIER

Eure et Loir Nogent Le Roi

65 rue du faubourg valmorin

## GARNITURES DE GRILLES DE CLOTURES

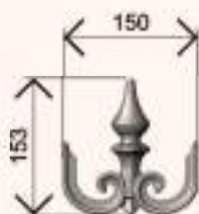

FCF

FCB



2831



FCH



FCJ



FCH et FCJ



FCD



145

FCM

72



FCK

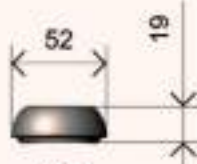

FCC



FCL

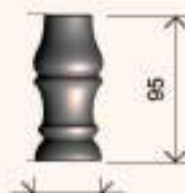

FCG



FCN



FCP



FCR



FCM

# LOISELET

Depuis 1850 à Nogent Le Roi Eure et Loir  
César Loiselet Créateur de l'industrie et de la fonte d'Art  
FONDERIE D'ART FONDERIE DE FONTE ET METALLIER

Eure et Loir Nogent Le Roi

65 rue du faubourg valmorin

MOULURE POUR PORTAIL



719  
3000\*50\*8

PORTES - GRILLES

pour entrée de parc ou jardin.

MOULURE POUR PORTAIL

212\*32\*12

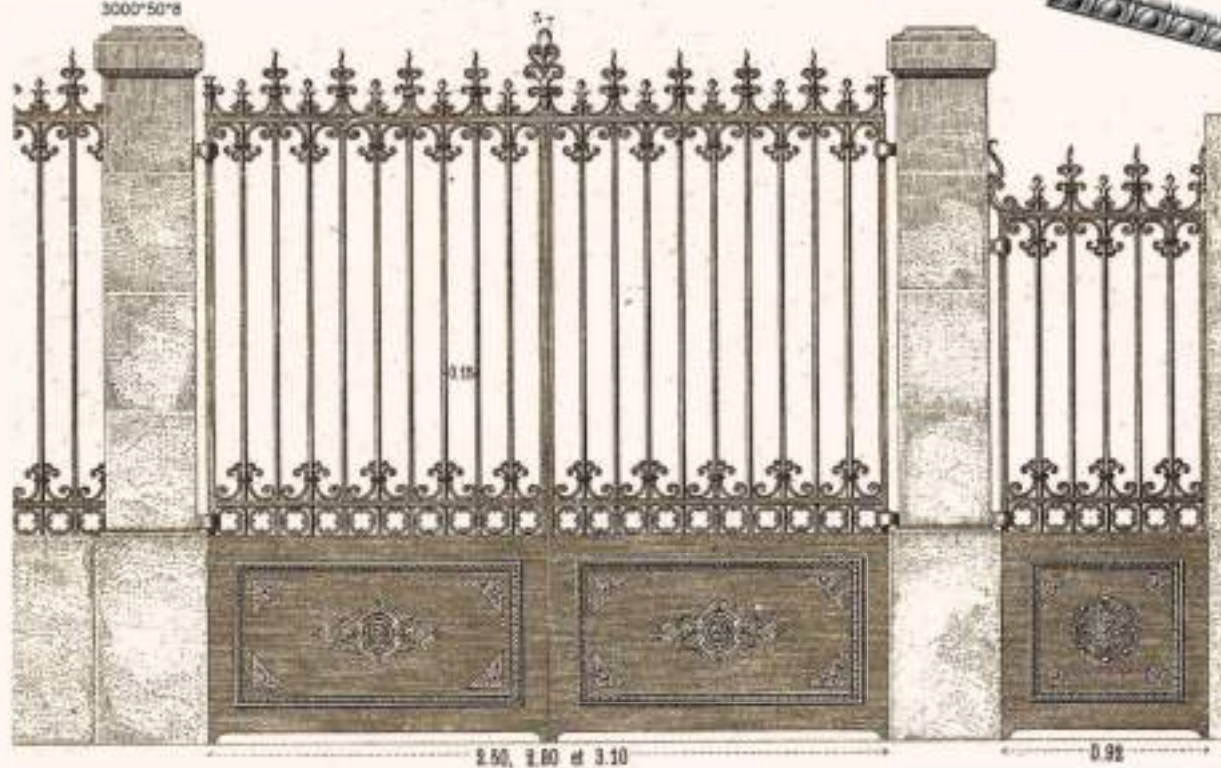

36

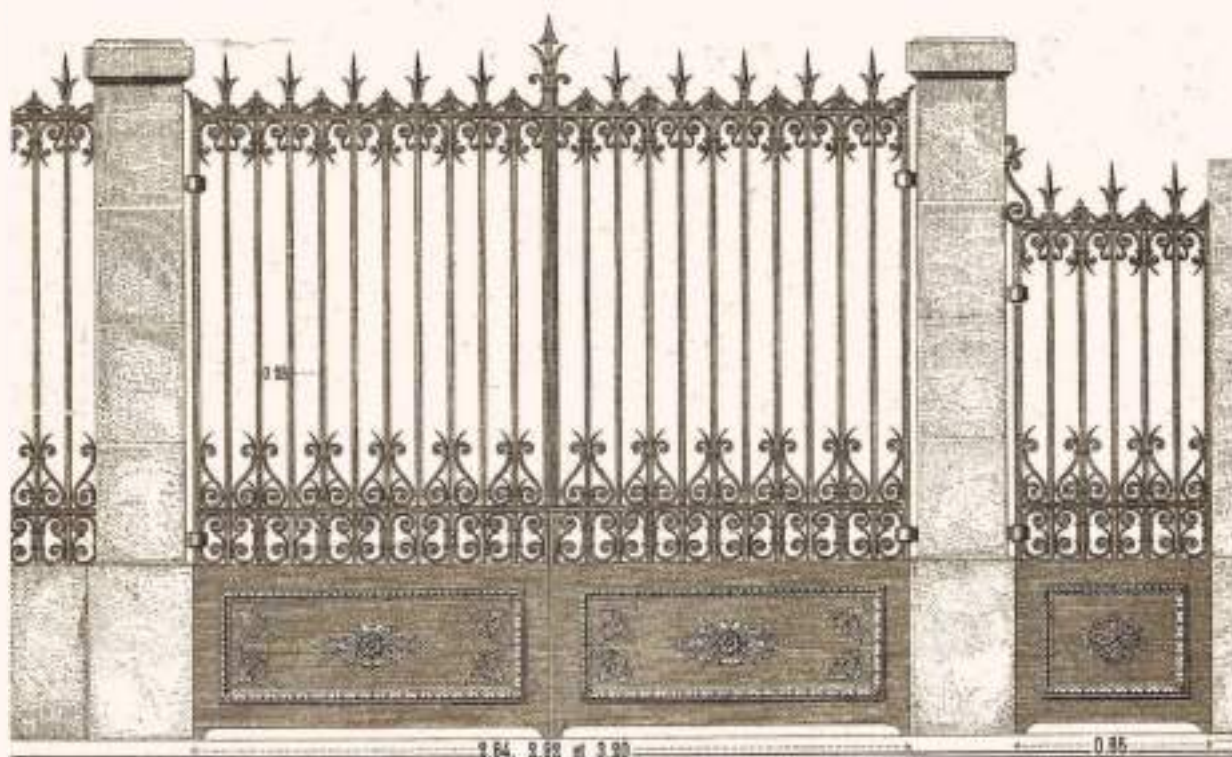

Au 33<sup>me</sup> d'exécution.

PLANCHE 92 COLLECTION LOISELET propriété de LOISELET reproduction interdite

COLLECTION REALISEE PAR M<sup>lle</sup> Raymonde, M<sup>lle</sup> Maud, M César, Henri, Albert, Jean, Yvon, François, Denis, Sylvain, Sébastien et Camille LOISELET

GRILLES CORBEILLES DE JARDIN

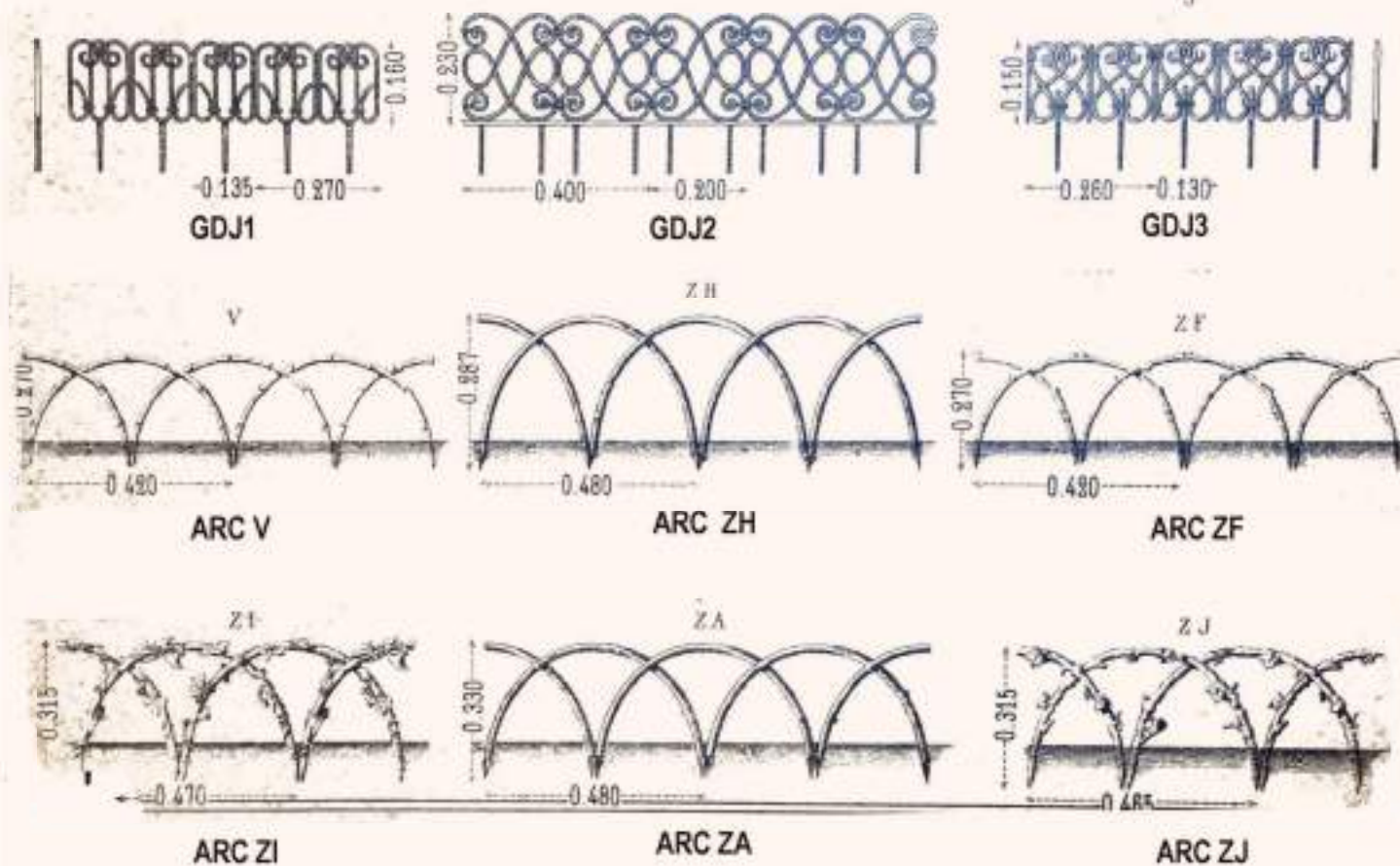

GRILLES DE SEPARATION DE JARDIN

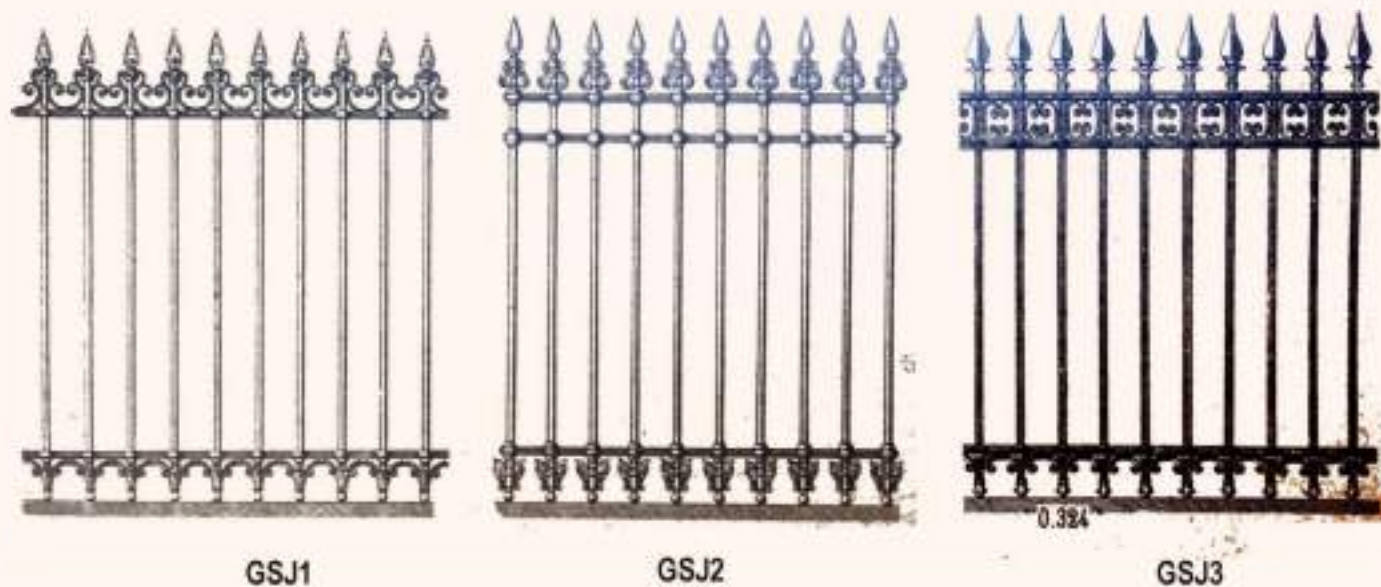

## COLONNE LOISELET

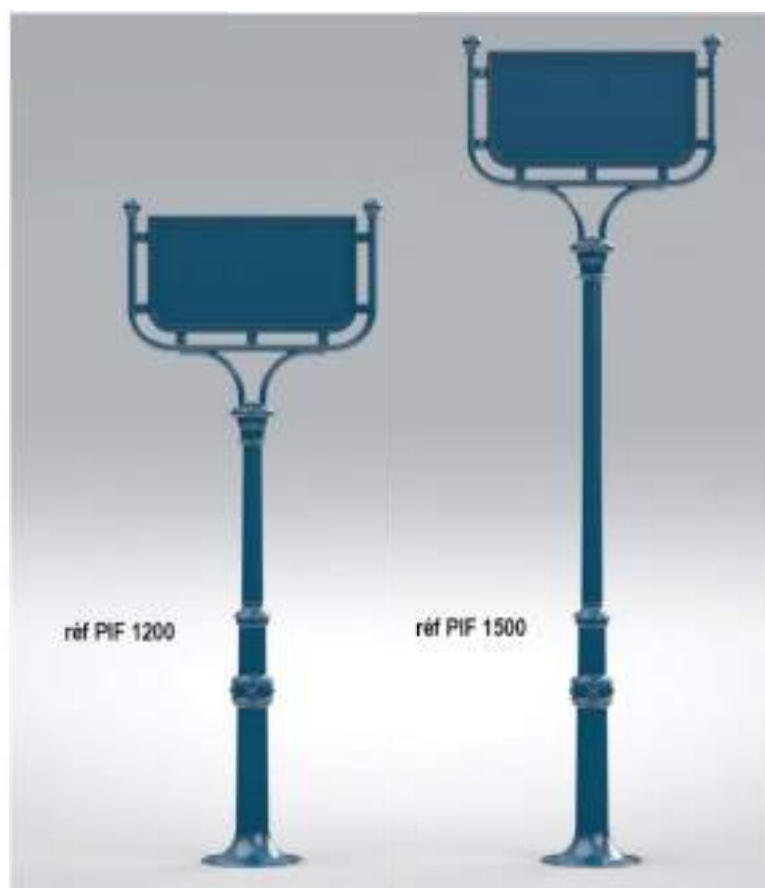

Poteau d'information en fonte résistante aux chocs

Hauteur variable de 1500 mm maxi  
largeur du panneau 380\*213mm

# Lampadaire

## Mobilier urbain

Utilisés depuis 1776 par la ville de Paris, le lampadaire, candélabre, réverbère en fonte garantit l'éclairage public tout en mettant en valeur une architecture moderne. Éléments de décor et d'illuminations essentiels pour les communes, la société Loiselet est prête à mettre toute son expertise pour réaliser vos projets.

Nous restaurons également à l'identique par reproduction votre lampadaire, éclairage, luminaire, réverbère, candélabre en fonte ou en fer forgé.



# Mobilier Urbain

## Lanterne et console

Mobilier urbain

### Lanterne en fonte

Luminaire en fonte, porté ou suspendu, idéal pour un éclairage efficace et conserver l'aspect authentique de votre architecture et de votre décoration.



potence PO37 fonte  
avec lanterne BG1  
ref PO37BG15

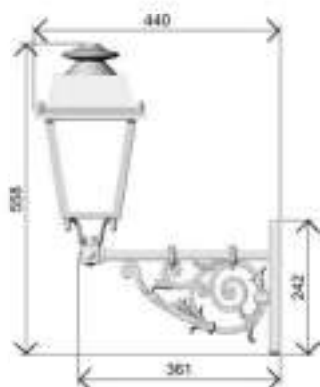
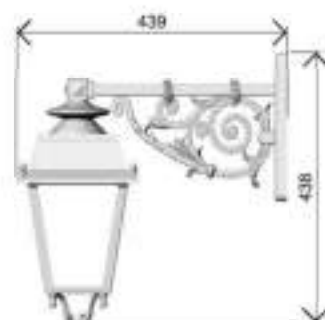

potence PO37 fonte  
avec lanterne BG1  
ref PO37BG1P



**DEMI BG2 APPLIQUE**  
450 \* 320mm



# Mobilier Urbain

## Lanterne et console

Mobilier urbain

### Lanterne en fonte

Luminaire en fonte, porté ou suspendu, idéal pour un éclairage efficace et conserver l'aspect authentique de votre architecture et de votre décoration.



# Banc

Mobilier urbain

## Banc en fonte et bois

Fabriqués en fonte et en bois par la famille Loiselet depuis 1850, retrouvez tous nos modèles de bancs, mobilier urbain design pour l'architecture urbaine. Ces bancs sont autant à destination des collectivités que des particuliers et peuvent être peints selon votre demande.

Nous restaurons également à l'identique par reproduction votre pied de banc en fonte ou en fer forgé.



### BANC VILLE DE PARIS SIMPLE

2000x615x H 980 mm

Hauteur d'assise : 430 mm

2 lattes : 135x35x2000 mm

1 latte : 135x45x2000 mm

pois : 67 kg



### BANC VILLE DE PARIS DOUBLE

2000x765x H 980 mm

Hauteur d'assise : 430 mm

4 lattes : 135x35x2000 mm

1 latte : 135x45x2000 mm

pois : 90 kg

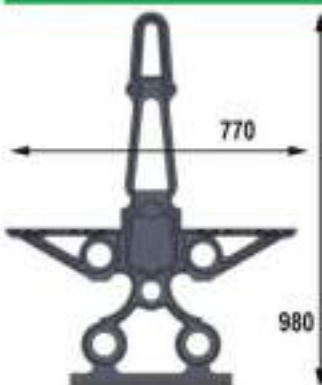

### BANC RENCONTRE

2000x765x H 860 mm

Hauteur d'assise : 430 mm

19 lattes : 30x35x2000 mm

pois : 53 kg



# Banc

Mobilier urbain



## BANC PROVINCIAL

2000x685x H 700 mm  
Hauteur d'assise : 440 mm  
11 lattes : 55x25x2000 mm  
poids : 68 kg

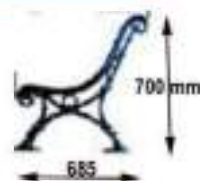

## BANC CONFORT

2000x565x H 680 mm  
Hauteur d'assise : 410 mm  
5 lattes : 90x35x2000 mm  
poids : 53 kg



## BANC URBAIN

2000x625x H 750 mm  
Hauteur d'assise : 490 mm  
5 lattes : 115x35x2000 mm  
poids : 54 kg



## BANC DÉTENTE

2000x520x H 680 mm  
Hauteur d'assise : 420 mm  
5 lattes : 90x35x2000 mm  
poids : 50 kg



# Banc

Mobilier urbain



## BANC PARISIEN

2000x675x H 750 mm  
Hauteur d'assise : 460 mm  
7 lattes : 90x35x2000 mm  
poids : 47 kg



## BANC PARISIEN XL

2500\*935 H 1100mm  
Hauteur d'assise : 640 mm  
7 lattes : 135\*35\*2500 mm  
Poids 100 kg



## BANC COMMUNAL

2000x650x H 680 mm  
Hauteur d'assise : 390 mm  
3 lattes : 115x35x2000 mm  
poids : 49 kg

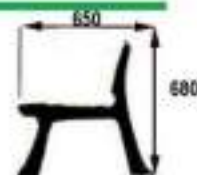

# Banc

Mobilier urbain



## BANC HUIT

2000x620x H 720  
Hauteur d'assise : 430 mm  
6 lattes : 135x35x2000 mm  
poids : 65 kg

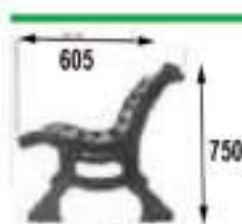

## BANC PUBLIC

2000x605x H 750 mm  
Hauteur d'assise : 450 mm  
10 lattes : 49,5x41x2000 mm  
poids : 64 kg

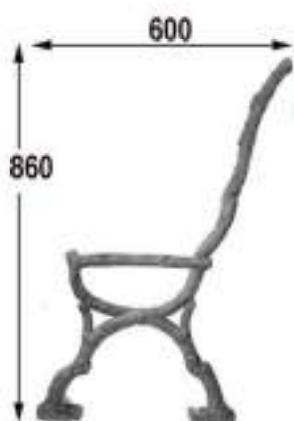

## BANC LIANE

200x600x h 860 mm  
Hauteur d'assise : 470 mm  
2 lattes : 115x35x2000 mm  
1 latte 175x35x2000 mm  
poids : 37 kg



## BANC SQUARE

2000x590x H 850 mm  
Hauteur d'assise : 440 mm  
2 lattes : 115x35x2000 mm  
1 latte : 135x35x2000 mm  
poids : 54 kg



# Banc

Mobilier urbain

## Banc en fonte et bois



### BANC MATERNELLE

1400x349x H 470 mm  
Hauteur d'assise : 290 mm  
3 lattes : 100x35x1400 mm  
poids : 22 kg

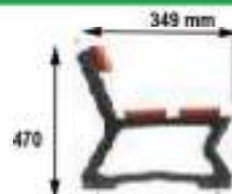

### BANC CHAMPÊTRE

2000x320x h440 mm  
Hauteur d'assise : 440 mm  
1 lattes : 310x35x2000 mm  
poids : 25 kg



### BANC RURAL

2000x365x H 420 mm  
Hauteur d'assise : 420 mm  
3 lattes : 90x35x2000 mm  
poids : 67 kg

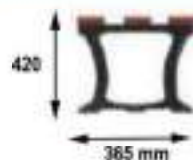

### BANC VILLE

2000x555x H 710 mm  
Hauteur d'assise : 460 mm  
5 lattes : 90x35x2000 mm  
poids : 48 kg



# Borne de rue & potelet

Mobilier urbain

## Borne en fonte

### BORNE DEMI-SPHÈRE

Hauteur : 200 mm  
Largeur : 300 & 400 mm  
Poids : 12 kg & 22 kg

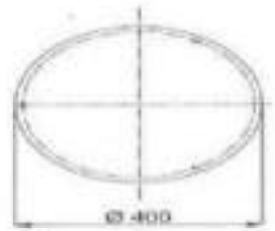
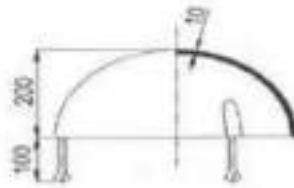
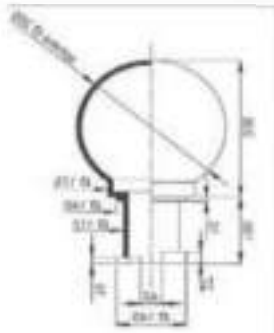

### BORNE SPHÈRE

Hauteur : 305 mm  
Largeur : 400 mm  
Poids : 28 kg & 56 kg

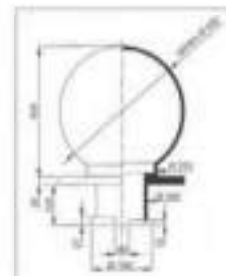

### BORNE SPHÈRE SUR PLATINE

Hauteur : 400 mm  
Largeur : 410 mm  
Poids : 66 kg  
Option disponible :  
Boitier amovible



### BORNE MARINE

Hauteur : 300 mm  
Largeur : 250 mm  
Poids : 25 kg  
Option disponible :  
Boitier amovible



### BOULE DIAM 90

Boule Diam 86 mm  
Pour potelet diam 76 mm



### POTELET A GORGE

Pour potelet diam 101 mm  
Hauteur 135+35mm

# Borne de rue & potelet

Mobilier urbain

## BORNE FLORENCE

Hauteur : 375 mm  
Largeur : 170mm  
Poids : 25 kg  
Option disponible :  
Boitier amovible



## BORNE VILLE

Hauteur : 650 mm  
Largeur : 220 mm  
Poids : 24 kg

## BORNE GRENADE

Hauteur : 700 mm  
Largeur : 240 mm  
Poids : 29 kg

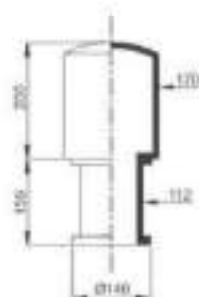

## BORNE URBAINE

Hauteur : 200 mm  
Largeur : 170 mm  
Poids : 12.5 kg  
Option disponible :  
Boitier amovible



# Borne prestige

Mobilier urbain

## Borne prestige 1

Dispositif de délimitation urbaine avec système d'accroches pour chaînes

Référence du Produit :  
BORNE PRESTIGE 1

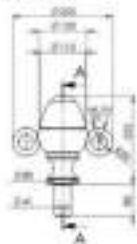

Borne en fonte

Finitions :

Peinture standard en noir, autre peinture sur demande

Option :

Chaîne en acier avec maillon à fixer aux oreilles

## Borne prestige 2

Dimensions globales (en mm) :

Avec deux oreilles : Ø : 158 X H : 145

Avec une oreille : Ø : 119 X H : 145

Sans oreille : Ø : 80 X H : 145



## Borne prestige 3



## Pergola



ref 22 colonne fonte et fer  
dessus découpe laser  
6000\*2500 hauteur 2500 mm



ref 8 colonne fonte  
4250\*3200 hauteur 2500 mm

## Gouttière fonte



# Fontaine

Mobilier urbain

## Fontaine en fonte

La fontaine en fonte est un atout décoratif du plus bel effet pour une commune voire même un jardin. Le choix du coloris de peinture peut servir à la fois pour réhausser le cachet d'antan de la structure ou encore pour se démarquer comme point d'alimentation en eau potable.

Nous restaurons également à l'identique, par reproduction, votre fontaine en fonte ou en fer forgé.



**FONTAINE AMNIS**  
L : 400 x P : 325 x H : 750

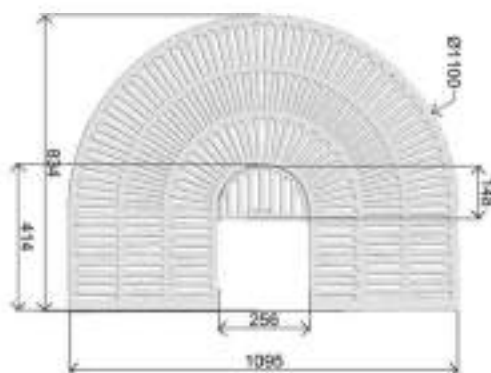

**GRILLE FONTAINE 1010 mm**  
GRDF - 95 KG



**VASE  
MEDICIS 835**

**HAUTEUR 835 / DIAMETRE 657mm**



**Table bistrot h716 L 500mm**



**H 1076 L 500**



**BOITE A EAUX**

## REPERES DE DEPART DE GOLF



Les repères de départs LOISELET sont bombés pour les voir de loin, ils sont incassables et fabriqués en fonte.  
Ils ont été conçus pour les conserver en place pendant la tonte des départs.

### FONTE

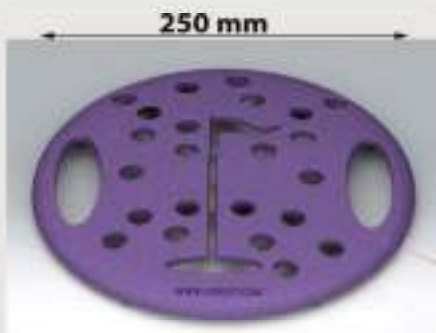

Le poids de la pièce permet une stabilité.  
Les 4 picots évitent les déplacements.  
Prix compétitifs.

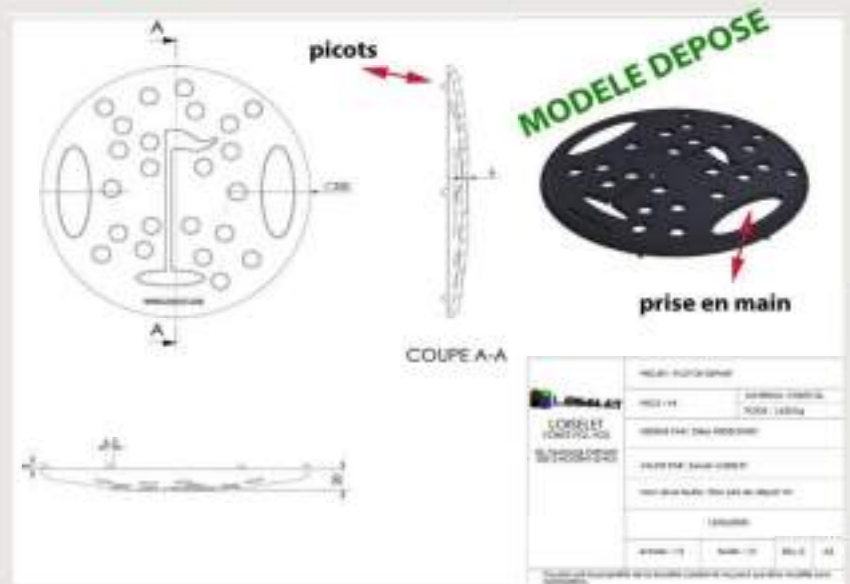

**COULEUR A LA DEMANDE**

**WWW.LOISELET.COM**

# LES ETAPES DE REPRODUCTION D'UNE PIECE EN FONTE



**PIECE EN FONTE A REPRODUIRE**



**CREATION DU PLAN 3D**



**CREATION D'UN VISUEL POUR VALIDATION**



**CREATION D'UN OUTILLAGE SUIVANT LE PLAN 3D**



**OUTILLAGE / MODELE PERMETTANT DE FABRIQUER UN MOULE**



**1/2 MOULE EN SABLE EN NEGATIF**



**FERMETURE DES 2 DEMI MOULES EN SABLE**



**REMPLISSAGE DE LA FONTE LIQUIDE A 1500° DANS LE MOULE EN SABLE**



**PIECE EN FONTE REPRODUITE**



**FONTE RESISTANTE AUX CHOCS ET CONFORME AUX NORMES NFP 01 013 ET NFP 01 012**

## INDEX

APPUIS DE FENETRE / BARRES D'APPUIS : pages 3 à 7

GRILLES DE BALCONS/ BALCONS DE CROISEES : pages 8 à 22, 42, à 46 et 71 à 72

BALUSTRADES : pages 23 à 34

MAIN COURANTE / PATTES DE SCHELLEMENT ET A VISSER : page 35

ACCESSOIRES POUR PORTAILS ET GARDE CORPS : pages 36 à 38

PIECES D'ESCALIERS ET ESCALIERS : pages 39 à 50

EQUERRES, LAMBREQUINS et GRILLES DE SEPARATION : page 51

PANNEAUX DE PORTE : pages 52 à 53

COLONNES : pages 54 à 64 et 79

GRILLES DE VENTILATION : page 65

BACS A ORANGER : page 66

GRILLES GRATTE PIEDS : page 67

ROSACES ET CACHES SCHELLEMENT : page 68

POINTES DE GRILLES : page 69

VOLUTES : page 70

MARQUISES : pages 73 à 74

PORTAILS : PAGE 75 à 77

GRILLES DE JARDIN ET GRILLES DE CLOTURES : page 78

LAMPADAIRES ET LANTERNES : pages 80 à 81

BANCS : pages 82 à 86

BORNES : pages 87 à 89

PERGOLAS : page 89

FONTAINE, VASE MEDICIS, TABLE : page 90

PLOT GOLF : PAGE 91

PLAQUES DE CHEMINÉE, ACCESSOIRES DE CHEMINEE, CONTRE POIDS, CONTRE POIDS TRACTEUR, MASSES DE LESTAGE, FONTE DE VOIRIE , ETC : CONSULTER [WWW.LOISLET.COM](http://WWW.LOISLET.COM)



CONTRE POIDS DE 6 A 50 KG



MASSES POUR ESSAIS DE CHARGES DE 25KG A 5 000KG



GALETTES POUR FERROVIAIRES ET TRAMWAY



CONTRE POIDS POUR POTEAU DIRECTIONNEL DE 5KG A 25KG



CONTRE POIDS DE TRACTEUR DE 15KG A 2 000KG



ROUE CROSKILETTE  
ROUE CAMBRIDGE  
ROUE POUR L'AGRICOLE



 **PLAQUES DE CHEMINEES  
PLUS DE 500 MODELES**



 **MOBILIER URBAIN  
BORNES, BANCS,  
LAMPADAIRES**



 **FONTE DE VOIRIE**



 **BACS A ORANGERS**



 **GRILLES DE CHAUFFAGE  
ET DE VENTILATION**



 **ESCALIERS FONTE  
ET FER FORGE**



 **APPUIS DE FENETRE, BALCONS  
GARDE-CORPS, BALUSTRADES  
RAMBARDES, PLUS DE 300 MODELES**



 **FONTE, GJL, GJS  
BRONZE**



 **BUREAU DE  
CONTROLE**



 **BUREAU D'ETUDES**



 **PEINTURE AU TREMPE  
ET AU PISTOLET**



 **PEINTURE EPOXY**



 **USINAGE**



 **300 TONNES DE PIECES EN  
STOCK A NOGENT LE ROI**

Fondeurs de fonte depuis 1850. 6 générations de fondeurs passionnés.  
Nous exportons notre savoir-faire renommé vers plus de 36 Pays.

[WWW.LOISELET.COM](http://WWW.LOISELET.COM)

Toute l'équipe des Fonderies LOISELET vous souhaite la bienvenue  
Loiselet 65 rue du faubourg Valmorin 28210 Nogent-le-Roi  
Tél : 02 37 65 37 42 ; 09 53 45 11 13 ; [welcome@loiselet.com](mailto:welcome@loiselet.com)

Langage :  
Français  
English  
Español  
Allemand